

X (2 : 1)

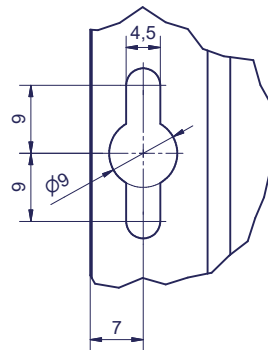

1	1	IPC/RSA2	COMPACT A2
Pos.	Menge	Einheit	Sachnummer
		Benennung / Merkmale	
		Werkstoff	
		Systemic Datentechnik AG Tafelstrasse 28 5405 Baden-Dätwil Switzerland Telefon +41 56 200 90 40 Fax +41 56 200 90 50	
HINWEIS: Diese Zeichnung ist unser Eigentum und darf ohne unsere Genehmigung weder vervielfältigt, noch dritten Personen zugänglich gemacht werden.		Artikel-Nr.	
Index	Änderungen	Datum	Name
a) ...-2			
b) ...-3			
c) ...-4			
d) ...-5			
e) ...-6			
f) ...-7			
g) ...-8			
		Masstab <b>1:2</b>	
		Mechanical Drawing <b>IPC/RSA2</b>	
		Zeichnungs-Nr. (Bauteilnummer) <b>COMPACT A2</b>	
		Blatt-Nr. <b>1</b>	
		Format <b>A2</b>	
EDV-Nr.: I:\Konstruktion\DATEN\Projekte\IPC\CompactA2\Compact-A2_Aluminium			

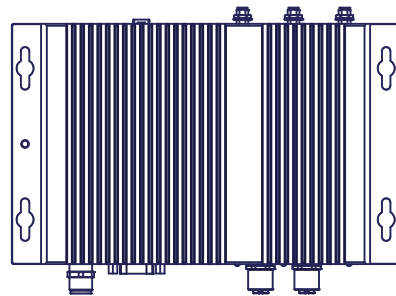
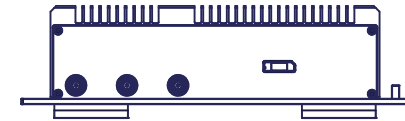
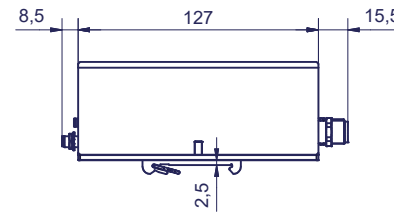
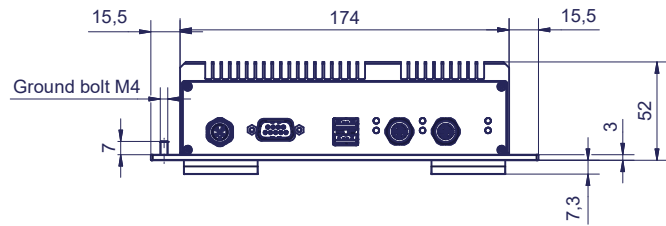
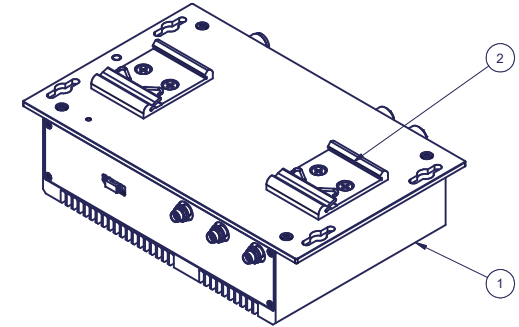
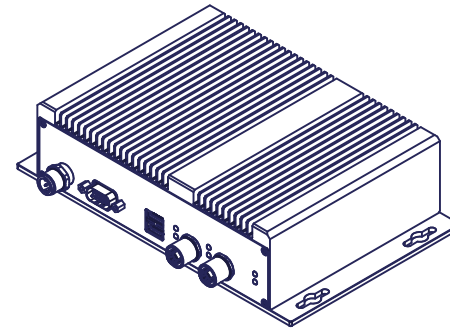
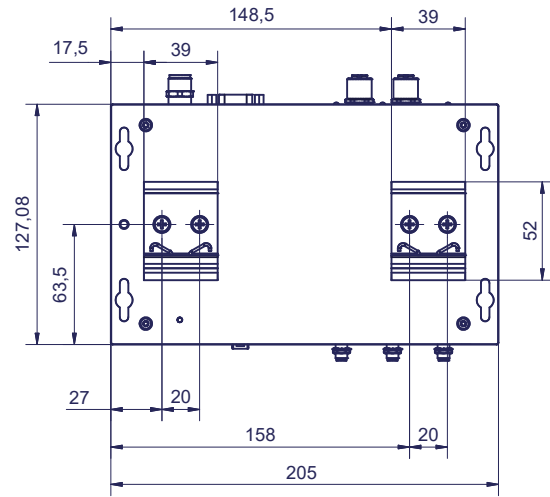

2	1		IPC/MKITCP-2G41	COMPACT A2 - DIN Rail Clip	
1	1		IPC/RSA2	COMPACT A2	
Pos.	Menge	Einheit	Sachnummer	Benennung / Merkmale	Werkstoff
			<b>syslogic</b>		
			Systemic Datentechnik AG Tafelstrasse 28 5405 Baden-Dätwil Switzerland Telefon +41 56 200 90 40 Fax +41 56 200 90 50		
				HINWEIS: Diese Zeichnung ist unser Eigentum und darf ohne unsere Genehmigung weder vervielfältigt, noch dritten Personen zugänglich gemacht werden.	
				Artikel-Nr.	
Index		Änderungen		Datum	
a) ...-2				Gezeichnet 25.01.17	
b) ...-3				Kontrolliert	
c) ...-4				Name	
d) ...-5					
e) ...-6				Masstab	
f) ...-7				1:2	
g) ...-8					
				Mechanical Drawing <b>IPC/RSA2</b>	
				Zeichnungs-Nr. (Bauteilnummer) <b>COMPACT A2</b>	
				Blatt-Nr. 2 Format A2	
EDV-Nr.: I:\Konstruktion\DATEN\Projekte_IPC\CompactA2\Compact-A2_Alu.lam					