

1	1	IPC/RMLA3	Sachnummer		COMPACT A3 - RML		Benennung / Merkmale	Werkstoff
Pos.		Menge	Einheit	Sachnummer		Benennung / Merkmale		Werkstoff
			Systemic Datentechnik AG Tafelstrasse 28 5405 Baden-Dätwil Switzerland Telefon +41 56 200 90 40 Fax +41 56 200 90 50			HINWEIS: Diese Zeichnung ist unser Eigentum und darf ohne unsere Genehmigung weder vervielfältigt, noch dritten Personen zugänglich gemacht werden.		Artikel-Nr.
Index		Änderungen	Datum	Name	Datum	Name	Mechanical Drawing	
a)	...				04.03.20	Andrea Meier	IPC/RMLA3	
b)	...						Zeichnungs-Nr. (Bauteilnummer)	
c)	...						Blatt-Nr.	
d)	...						1	
e)	...						Format	
f)	...						A2	
g)	...							
EDV-Nr.: I:\Konstruktion\DATEN\Projektel_IPC\CompactA3\RMLA3.lam								

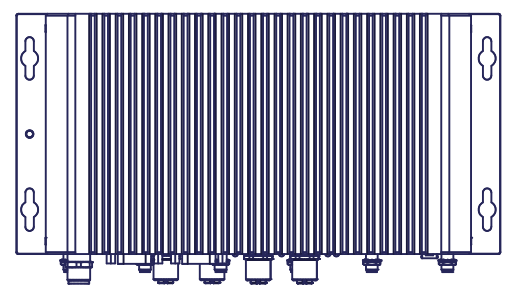
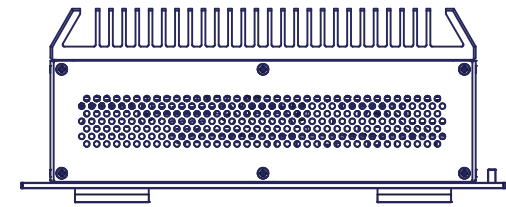
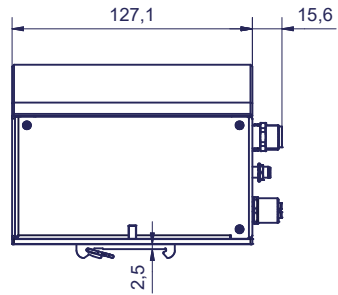
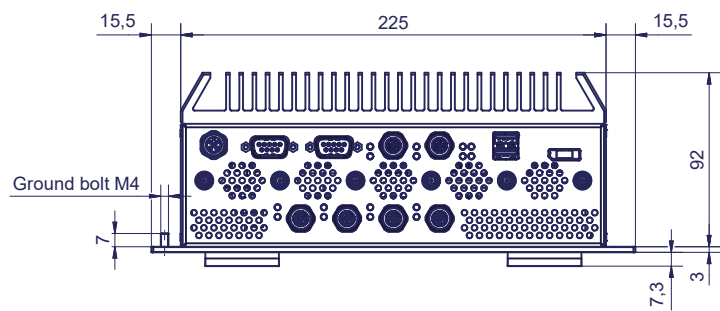
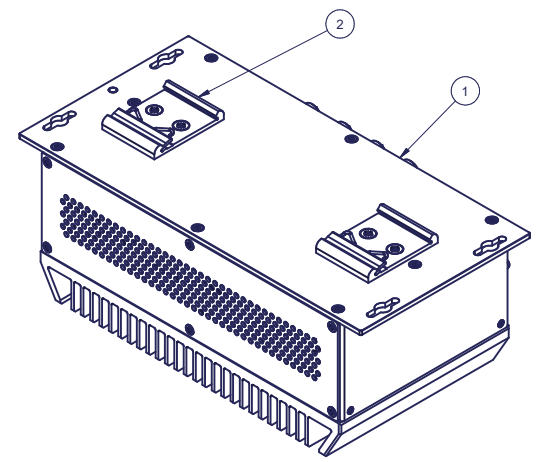
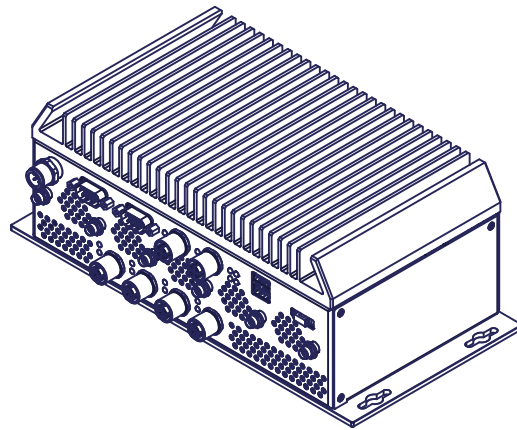
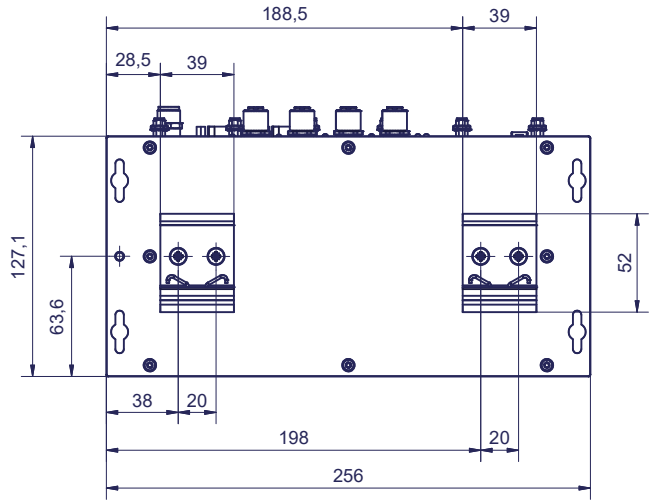

2	1		IPC/MKITCP-2G41	COMPACT - DIN Rail Clip	
1	1		IPC/RMLA3	COMPACT A3 - RML	
Pos.	Menge	Einheit	Sachnummer	Benennung / Merkmale	Werkstoff
			syslogic		
			Systemic Datentechnik AG Tafelstrasse 28 5405 Baden-Dätwil Switzerland Telefon +41 56 200 90 40 Fax +41 56 200 90 50		
				HINWEIS: Diese Zeichnung ist unser Eigentum und darf ohne unsere Genehmigung weder vervielfältigt, noch dritten Personen zugänglich gemacht werden.	
				Artikel-Nr.	
Index	Änderungen	Datum	Name	Datum	Name
a) ...-2			Gezeichnet	04.03.20	Andrea Meier
b) ...-3			Kontrolliert		
c) ...-4			Num.		
d) ...-5					
e) ...-6					
f) ...-7					
g) ...-8					
			Masstab 1:2		
				Mechanical Drawing IPC/RMLA3	
				Zeichnungs-Nr. (Bauteilnummer) COMPACT A3 - RML	
				Blatt-Nr. 2 Format A2	
EDV-Nr.: I:\Konstruktion\DATEN\Projektel_IPC\CompactA3\RMLA3.lam					