

## IPC/M8xxx-AyyyE

Document Ordercode: DOC/IPC\_M8-E

Revision	Date	Author	Modification
1.0	19.12.2016	F. Liechi	First release.
1.1	31.01.2017	F. Liechi	RS485 termination corrected
1.2	15.12.2017	U. Müller	Updated errata list

## Contents

<b>1</b>	<b>Introduction</b>	<b>5</b>
1.1.	General Remarks	5
1.2.	Contents of this Documentation	5
1.3.	Additional Products and Documents	5
1.3.1.	Documents	5
1.4.	Items delivered	5
1.5.	Installation	5
1.6.	Safety Recommendations	6
1.7.	Safety warnings	6
1.8.	Electro Static Discharge	6
1.9.	Life Cycle Information	6
1.9.1.	Transportation and Storage	6
1.9.2.	Assembly and Installation	6
1.9.3.	Operation	6
1.9.4.	Maintenance and Repair	7
1.9.5.	Disposal	7
1.9.6.	Warranty	7
1.9.7.	RoHS	7
1.9.8.	WEEE	7
<b>2</b>	<b>Product Description</b>	<b>8</b>
2.1.	Features	8
2.2.	Product Variants	10
2.3.	Operating Modes	10
2.4.	Startup Modes	10
<b>1</b>	<b>Hardware Description</b>	<b>12</b>
1.1.	Overview	12
2.5.	Memory and I/O Resources	14
2.5.1.	General Memory Layout and Configuration	14
2.5.2.	General I/O Layout and Configuration	15
2.6.	Peripheral Devices	18
2.6.1.	DVI Interface	18
2.6.2.	Buzzer Interface / Buzzer (optional)	18
2.6.3.	CFast-Interface	19
2.6.4.	Serial Ports	19
2.6.5.	RS485 FD/RS422 Termination	21
2.6.6.	RS485 HD Termination	21
2.6.7.	USB Interface	21
2.6.8.	Ethernet LAN Interface	22
2.6.9.	CAN Interface	22
2.6.10.	I2C Interface	23
2.6.11.	Watchdog	23
2.6.12.	Power supply	24
2.6.13.	Power supervision	24
2.6.14.	Power Fail	24
2.6.15.	Remote On/Off	25
2.6.16.	Front Side Status LEDs	27
2.6.17.	Ground-Shield connection	27
<b>3</b>	<b>Programming Information</b>	<b>28</b>
3.1.	Overview	28
3.2.	Interrupt, Memory and I/O Resources	28
3.2.1.	Interrupt Resources	28
3.2.2.	Memory Resources	29
3.2.3.	I/O Resources	29
3.3.	Peripheral Devices	37

3.3.1.	DVI/LCD-Interface	37
3.3.2.	SATA/CFast-Interface	37
3.3.3.	Serial Ports	37
3.3.4.	Ethernet Interface	37
3.3.5.	USB Interface	37
3.3.6.	CAN Interface	37
3.3.7.	Temperature Sensor	37
3.3.8.	Watchdog	38
<b>4</b>	<b>Installation and cabling</b>	<b>39</b>
4.1.	Introduction	39
4.2.	Maximum cable length	39
4.3.	Power supply	40
4.4.	Powering the M8 System	40
4.5.	Cabling the interfaces	40
4.6.	Grounding	40
4.7.	Cabling of communication links	42
<b>5</b>	<b>Service</b>	<b>43</b>
5.1.	Replaceable Parts	43
<b>6</b>	<b>Technical Data</b>	<b>44</b>
6.1.	Electrical Data	44
6.2.	EMI/EMC Data	46
6.2.1.	Restrictions	46
6.2.2.	Mechanical Data	46
<b>7</b>	<b>Firmware</b>	<b>47</b>
7.1.	Software Structure	47
7.2.	Firmware Functions	47
7.3.	Application Programming Interface (API)	47
<b>8</b>	<b>Product Revision History</b>	<b>48</b>
8.1.	Hardware	48
8.2.	Firmware	48
8.1.	Erratas	49
<b>9</b>	<b>Manufacturer Information</b>	<b>50</b>
9.1.	Contact	50
9.1.1.	RMA Service	50
<b>List of Tables</b>		
Tab. 1	Items delivered	5
Tab. 2	Features M8	10
Tab. 3	Startup Modes	11
Tab. 4	Physical Memory Address Space Layout	15
Tab. 5	I/O Address Space Layout	17
Tab. 6	Factory Programming Header P11 (1x6 pin)	17
Tab. 7	Factory Programming Header P12 (1x4 pin)	17
Tab. 8	Factory Programming Header P17 (1x7 pin)	17
Tab. 9	DVI-D connector P5 (DSUB15HD)	18
Tab. 10	Buzzer interface connector P3	19
Tab. 11	CFast Connector P8 (SATA Channel 0)	19
Tab. 12	Serial Port setup	20
Tab. 13	Serial Ports RS232 COM1-COM6 (DSUB-9 male)	20
Tab. 14	Serial Ports RS485 Half Duplex configuration on X1, X2 (DSUB-9 male)	20
Tab. 15	Serial Ports RS485 Half Duplex configuration on X1, X2 (DSUB-9 male)	20
Tab. 16	Serial Ports RS422 configuration on X1, X2 (DSUB-9 male)	21
Tab. 17	RS485 FD and RS422 termination	21
Tab. 18	RS485 HD termination	21
Tab. 19	USB1/2 Interface Connector P20 (Dual Type A)	21

Tab. 20	USB4/5 Interface Connector P22 and P26 (2x2pin)	21
Tab. 21	Ethernet Twisted Pair Interface Connector P18 and P19 (RJ45)	22
Tab. 22	CAN Interfaces	23
Tab. 23	Pin assignment of CAN interface: X1 at P30 / X2 at P31	23
Tab. 24	CAN Termination settings	23
Tab. 25	I2C Interface Connector P46	23
Tab. 26	Watchdog Configuration Options	24
Tab. 27	Power supply connector	24
Tab. 28	Power fail input configuration	24
Tab. 29	Power fail mode configuration	24
Tab. 30	PCU timing configuration through S14	25
Tab. 31	Front side LED	27
Tab. 32	Ground shield connection	27
Tab. 33	Interrupt Usage	28
Tab. 34	M8 System RegistersStatus Register 8200h	29
Tab. 35	Maximum cable length	39
Tab. 36	General Absolute Maximum Ratings	44
Tab. 37	General Recommended Operating Conditions	44
Tab. 38	General Electrical Characteristics	45
Tab. 39	General Switching Characteristics	45
Tab. 40	Hardware Revision State	48
Tab. 41	Firmware Revision State	48

### List of Figures

Fig. 1	Block Diagram Mainboard	9
Fig. 2	Block Diagram Extension board	9
Fig. 3	Features front view	12
Fig. 4	Features rear view	12
Fig. 5	Board Layout Main-Board	13
Fig. 6	Board Layout Expansion Board	14
Fig. 7	Memory Map	15
Fig. 8	Power supply connector	24
Fig. 9	Typical power fail application	25
Fig. 10	Typical power fail flow	25
Fig. 11	Application example: CAR PC	26
Fig. 12	Startup timing diagram	26
Fig. 13	Shutdown timing diagram	26
Fig. 14	J1 Ground-Shield connection	27
Fig. 15	Additional grounding of the cable shields at the entry point of a cabinet.	41
Fig. 16	Non isolated communication link with common chassis potential	42
Fig. 17	Isolated communication link	42
Fig. 18	Service parts replacement	43
Fig. 19	Drawings (bottom view, side view)	46

# 1 Introduction

## 1.1 General Remarks

The content and presentation of this document has been checked carefully. No responsibility is accepted for any errors or omissions in the documentation.

Note that the documentation for the products is constantly revised and improved. The right to change this documentation at any time without notice is therefore reserved.

Syslogic is grateful for any help referring to errors or for suggestions for improvements.

The following registered trademarks are used:

SPI	trademark of Motorola
PC	trademark of Philips Corporation
CFast	trademark of CompactFlash Association

## 1.2 Contents of this Documentation

This document addresses to system integrators, programmers and instructed installation and maintenance personal working with the COMPACT M8 system. It provides all information needed to configure setup and program the M8xxx-AyyyE. As the M8xxx-AyyyE may be delivered in various versions the standard version is described here and is referenced as M8 within this document.

## 1.3 Additional Products and Documents

### 1.3.1 Documents

The following additional documents are *useful* for correct installation and operation of the S8 system:

- DOC/IPC\_IOCOWSW: User Documentation for programming examples and utilities

The following documents are *useful* for additional information about MiniPCIe:

- PCIe Base Specification Version 1.1
- PCIe Mini Card Electromechanical Specification Version 1.2

The MiniPCIe Specification may be downloaded from the Internet (see address below).

- PCI-SIG Consortium  
[www.pcisig.com/specifications/pciexpress/base](http://www.pcisig.com/specifications/pciexpress/base)

## 1.4 Items delivered

The M8 with the following components:

Description	Article Code	Remarks
M8:	IPC/M8xxx-AyyyE	According to the specifications
Battery:	CPN/CR2450N	
Power Connector:	CPN/BLWBCZ38-4FSW	
Mounting options:	CPN/DINCLIP-32X59B	2 x DIN-Clip

Tab. 1 Items delivered

Additional items as flash or power supplies must be ordered separately and installed according to the respective user documentations.

## 1.5 Installation

The installation of the M8 system is described in chapter 4 of this documentation.

### Important Note

Before applying power to the M8 system, all installed boards must be correctly configured and mounted.

## 1.6. Safety Recommendations

The products are intended for measurement, control and communications applications in industrial environments. The products must be assembled and installed by specially trained people. The strict observation of the assembly and installation guidelines is mandatory.

The use of the products in systems in which the life or health of persons is directly dependent (e.g. life support systems, patient monitoring systems, etc.) is not allowed.

The use of the products in potentially explosive atmospheres requires additional external protection circuitry which is not provided with the products.

In case of uncertainty or of believed errors in the documentation please immediately contact the manufacturer (address see chapter 8.2). Do not use or install the products if you are in doubt. In any case of misuse of the products, the user is solely liable for the consequences.

## 1.7. Safety warnings

Do not operate this product outside of the recommended operating conditions according to the technical data specified in paragraph 5.

Do not touch the surface of this product without precaution, it may be hot and burn your skin. Cool it down before touching.

Do not touch any connector unless you have verified that no dangerous voltage is around. Disconnect cabling first.

Do not open any part of the enclosure while power is applied.

Do not try to repair any defective product by yourself. There is no replaceable service part inside.

Do not open the service cover unless you are instructed and entitled to do this. The service cover is intended for inserting the CFast software storage card on initial operation of the product by an instructed person only.

Use an overload protected power supply to prevent damage in case of a short inside the system.

## 1.8. Electro Static Discharge

Electronic boards are sensitive to Electro-Static Discharge (ESD). Please ensure that the product is handled with care and only in an ESD protected environment. Otherwise a proper operation is not guaranteed and the warranty is not applicable.

## 1.9. Life Cycle Information

### 1.9.1. Transportation and Storage

During transportation and storage the products must be in their original packing. The original packing contains shock-absorbing material. It is recommended to keep the original packing in case of return of the product to the factory for repair. Note that the packing is recyclable.

### 1.9.2. Assembly and Installation

Observe the EMI-precautions against static discharge. Carefully read the assembly and installation documentation (see chapter 4) before unpacking the products. Make sure that you have all the necessary items ready (including all the small parts). Follow the assembly guidelines in chapter 4 strictly.

The installation procedures must be strictly observed. Note that deviations from the installation guidelines may result in degraded operational reliability or in unfavorable EM-radiation or EM-susceptibility.

### 1.9.3. Operation

The operating environment must guarantee the environmental parameters (temperature, power supply, etc.) specified in the technical specification section of the product manuals.

The main functionality of the M8 system is defined by the application programs running on the processor board. The application programs are not part of the delivery by Syslogic but are defined, developed and tested by the customer or a system-integrator for each specific application. Refer to the respective documentation for more information.

#### **1.9.4. Maintenance and Repair**

The IPC system features error- and malfunction-detection circuitry. Diagnostic information gathered is transferred to the applications software where it can be used. In the rare case of a module hardware-failure or malfunction, the complete system should be exchanged. The faulty system must be returned to the factory for repair.

For best maintenance and repair service it is recommended to use the Syslogic RMA Service. Refer to Chapter 9.1.1.

Please use whenever possible the original packing for return of the product (EMI and mechanical protection).

#### **1.9.5. Disposal**

At the end of the lifespan the M8 products must be properly disposed. M8 products contain a multitude of elements and must be disposed like computer parts. Some of the M8 products contain batteries which should be properly disposed.

#### **1.9.6. Warranty**

Our products are covered by a world-wide manufacturer's warranty. The warranty period starts at the delivery time from our official distributor to the customer. The duration of the warranty period is specified in the respective product catalogs and the offers. All products carry a date code and a job number for identification. The manufacturing data and deliveries are registered in a high level Quality Management System.

The warranty covers material and manufacturing defects. All products must be returned via the official distributor to the factory for repair or replacement. The warranty expires immediately if the products are damaged or operation outside of the specified recommended operating conditions. The warranty also expires if the date code or job number listed on the product is altered or rendered unintelligible. The warranty does not include damage due to errors in firmware or software delivered with the products.

For best warranty service it is recommended to use the Syslogic RMA Service. Refer to Chapter 9.1.1.

#### **1.9.7. RoHS**

The products of the M8 family are designed and produced according to the Restriction of Hazardous Substances (RoHS) Directive (2002/95/EC).

#### **1.9.8. WEEE**

The products of the M8 are not designed ready for operation for the end-user and intended for consumer applications. Therefore the Waste Electrical and Electronic Equipment (WEEE) Directive (2002/96/EC) is not applicable. But users should still dispose the product properly at the end of life.

## 2 Product Description

### 2.1 Features

The M8 system is an x86 based embedded PC designed for use with the IPC line of communications and I/O boards. Its many different variants allow building various industrial controls based on the standard PC/AT architecture.

The M8 offers the following main features:

- low power industrial processor board eliminating the need for enforced cooling
- high performance 64-bit Intel Atom based processor core with integrated floating point unit
- up to 1.9 GHz processor clock
- DDR3 DRAM memory
- up to 8 Gbyte DRAM on board
- 64-bit graphics controller
- graphics controller supporting up to 1900 x 1200 dots resolution on DVI-D port
- SATA interface supporting one CFAST card socket and one standard SATA port.
- integrated peripheral controller (IPC) with PC/AT compatible DMA controllers (2 x 8237), interrupt controllers (2 x 8259) and timer/counter channels (8254)
- PC/AT compatible keyboard controller (8042)
- up to six serial RS232 ports (COM1-6) with 16 byte receive and transmit fifo (16550A)
- one USB V3.0/ V2.0 port (XHCI-Hostcontroller) with Super-, High-, Full- and Low-Speed support
- two USB V2.0 ports (OHCI/EHCI-Hostcontroller) with High-, Full- and Low-Speed support
- up to three 10/100/1000Mbit Ethernet LAN interfaces
- hardware watchdog configurable for 100 ms to 256 s timeout and Non-maskable Interrupt (NMI) or hardware reset activation
- temperature supervisor for software controlled power management
- Flash for BIOS and BIOS extensions
- supervised battery backup for Real Time Clock
- up to 2 CAN 1mBit Interfaces
- up to 2 isolated and software configurable RS485 HD, RS485FD or RS422 serial ports.



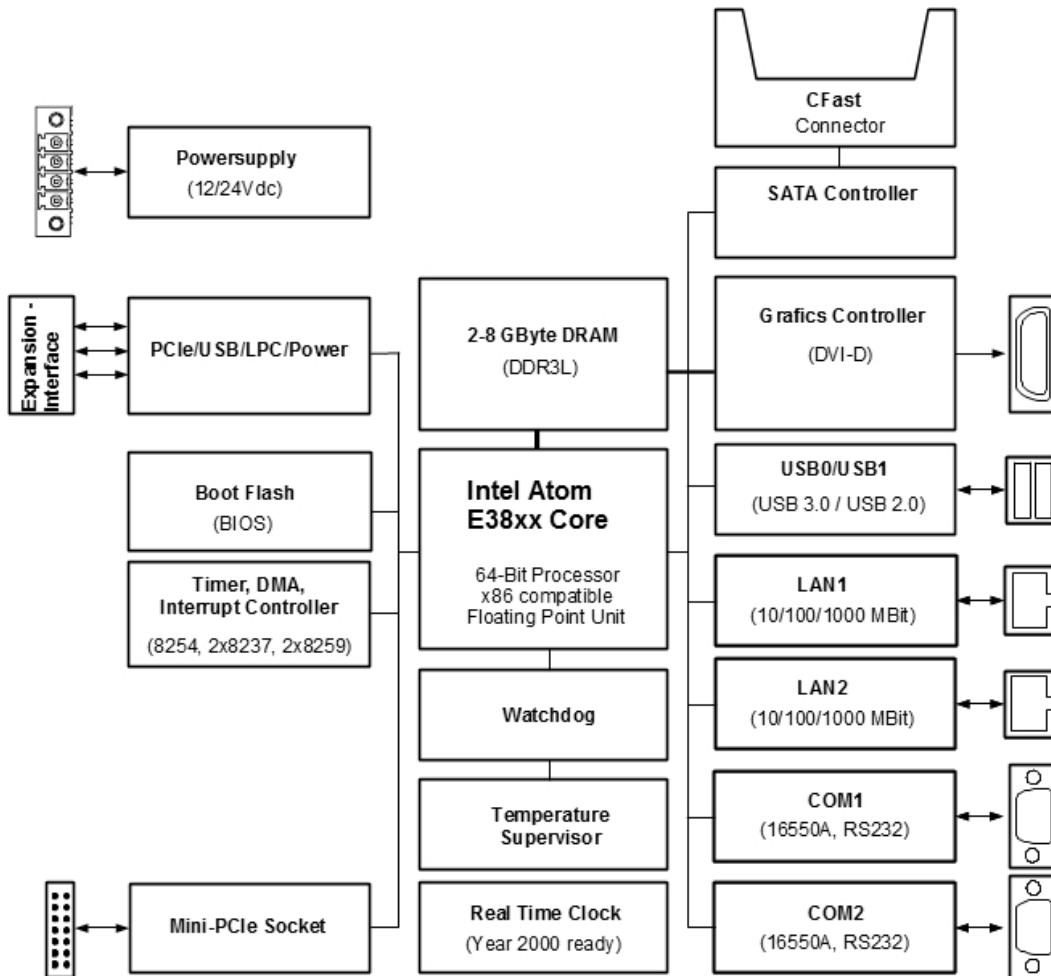

Fig. 1 Block Diagram Mainboard

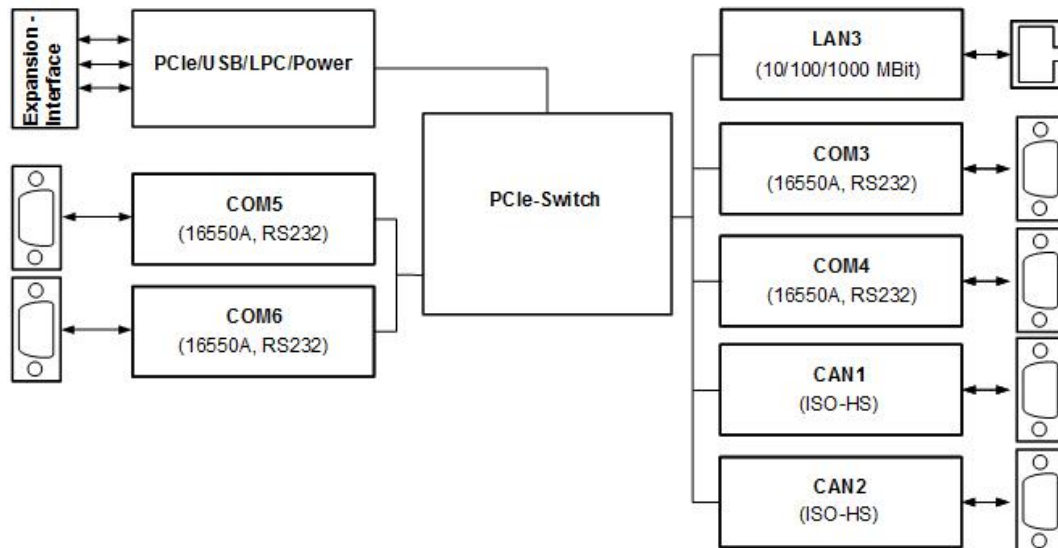

Fig. 2 Block Diagram Extension board

**Important Note**

Check the product variant carefully for the supported functions.

## 2.2. Product Variants

The M8 is available in different functional variants and enclosures.

<b>Kunde</b>	<b>IPC/M8H19-A201E</b>	<b>IPC/M8H19-A202E</b>	<b>IPC/M8H19-A203E</b>
CPU	<i>E3845, Quad-Core</i>	<i>E3845, Quad-Core</i>	<i>E3845, Quad-Core</i>
Memory	<i>4GB</i>	<i>4GB</i>	<i>4GB</i>
Display Interface DVI-D	<b>DISPLAY</b>	<b>DISPLAY</b>	<b>DISPLAY</b>
1Gbit Ethernet	<b>LAN1</b>	<b>LAN1</b>	<b>LAN1</b>
Ethernet (RJ45, Front)	<b>LAN2</b>	<b>LAN2</b>	<b>LAN2</b>
Ethernet (RJ45, Front)	<b>LAN3</b>	<b>LAN3</b>	<b>LAN3</b>
Serial Interface COM1	<b>COM1 (RS232)</b>	<b>COM1 (RS232)</b>	<b>COM1 (RS232)</b>
Serial Interface COM2	<b>COM2 (RS232)</b>	<b>COM2 (RS232)</b>	<b>COM2 (RS232)</b>
Serial Interface COM3	<b>COM3 (RS232)</b>	<b>COM3 (RS232)</b>	<b>COM3 (RS232)</b>
Serial Interface COM4	<b>COM4 (RS232)</b>	<b>COM4 (RS232)</b>	<b>COM4 (RS232)</b>
Serial Interface COM5	-	<b>RS422/485 (X1)</b>	<b>COM5 (RS232)</b>
Serial Interface COM6	<b>RS422/485 (X2)</b>	<b>RS422/485 (X2)</b>	<b>COM6 (RS232)</b>
CAN 2.0 a/b	<b>X1</b>	-	<b>X1</b>
CAN 2.0 a/b	-	-	<b>X2</b>
USB1/2	<b>USB1/2</b>	<b>USB1/2</b>	<b>USB1/2</b>
USB3	<i>P21</i>	<i>P21</i>	<i>P21</i>
USB4	<i>P26</i>	<i>P26</i>	<i>P26</i>
RTC Backup	<i>Battery</i>	<i>Battery</i>	<i>Battery</i>
cFast Interface	<i>P8</i>	<i>P8</i>	<i>P8</i>
Micro SD	<i>P7</i>	<i>P7</i>	<i>P7</i>
Power	<i>09-30VDC (not isolated)</i>	<i>09-30VDC (not isolated)</i>	<i>09-30VDC (not isolated)</i>
MiniPCIe slot	<i>P52</i>	<i>P52</i>	<i>P52</i>

Tab. 2 Features M8

Bold printed functions are available on a front or rear connector. Refer to Fig. 3 and Fig. 4

Italic printed functions are available as internal interfaces only. Refer to Fig. 5 and Fig. 6 for location of the internal interfaces.

## 2.3. Operating Modes

The M8 is based on the standard PC/AT architecture and therefore operates in DOS-compatible mode (real mode) on start up. The configurable BIOS initializes all onboard peripherals to their default values, executes the BIOS extensions programmed into the onboard BIOS-Flash and BIOS extensions found on installed expansion boards prior to booting the operating system from a user-selectable drive (boot sector). The operating system (or eventually a BIOS extension) may switch to protected mode to execute high performance 32-bit or 64-bit program code.

## 2.4. Startup Modes

The M8 may startup either in normal operating mode or in BIOS recovery mode:

BIOS recovery mode is invoked when rotary switch S1 is set to position '8'.

In BIOS recovery mode is intended to reprogram corrupt main BIOS. Before starting the reprogram process, switch S1 must be reset to position '0', otherwise the recovery BIOS will be overwritten.

Normal operating mode is invoked when rotary switch S1 is set to position '0'.

Switch S1	Startup Mode	Backlight Polarity	Backlight Control	Watchdog Base Timeout
0	normal operating modes	normal	by BIOS setting	1 s
1		normal	by BIOS setting	100ms
2		normal	by PWM Register 820Dh	1 s
3		normal	by PWM Register 820Dh	100ms
4		inverted	by BIOS setting	1 s
5		inverted	by BIOS setting	100ms
6		inverted	by PWM Register 820Dh	1 s
7		inverted	by PWM Register 820Dh	100ms
8	BIOS recovery mode	normal	by BIOS setting	1 s
9	factory modes (do not use)	normal	by BIOS setting	1 s
A		normal	by PWM Register 820Dh	1 s
B		normal	by PWM Register 820Dh	1 s
C	factory modes (do not use)	inverted	by BIOS setting	1 s
D		inverted	by BIOS setting	1 s
E		inverted	by PWM Register 820Dh	1 s
F		inverted	by PWM Register 820Dh	1 s

Tab. 3 Startup Modes

# 1 Hardware Description

## 1.1. Overview

The M8 hardware may be configured by software (CMOS setup) and by switch settings. Custom BIOS configuration can be programmed into the BIOS flash on request (ask Syslogic technical support for custom BIOS configuration).

The switch and connector locations are shown in the board layout drawing (Fig. 5 and Fig. 6).

### Important Note

Always check the jumper configuration of a freshly received board to comply with your system requirements before applying power, otherwise the system may get damaged or may fail to operate.

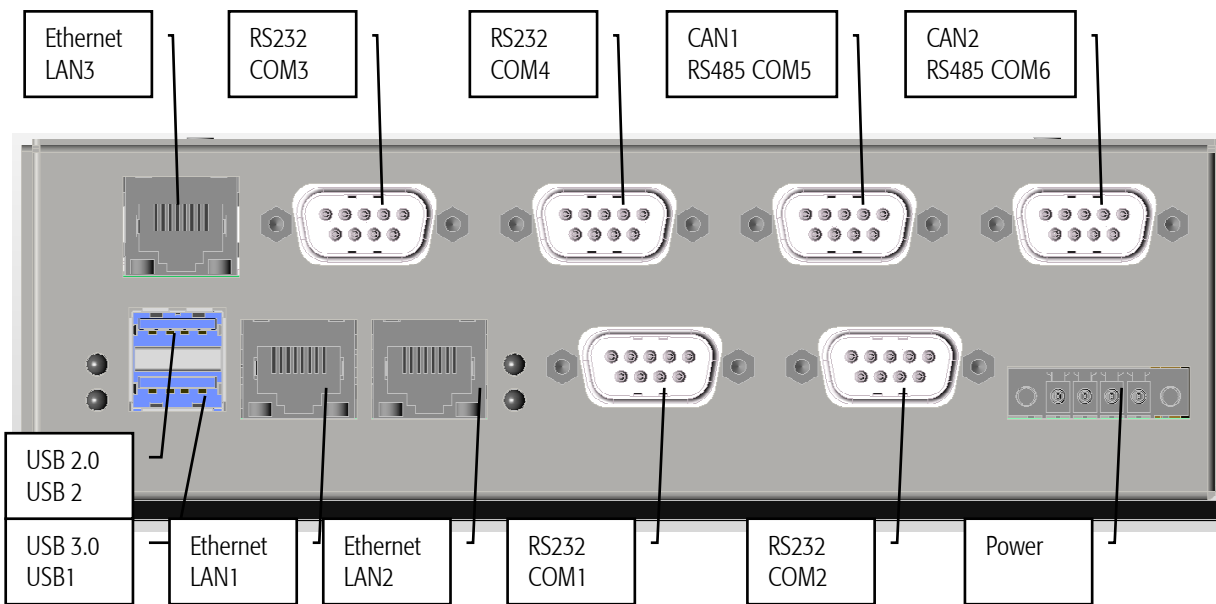

Fig. 3 Features front view

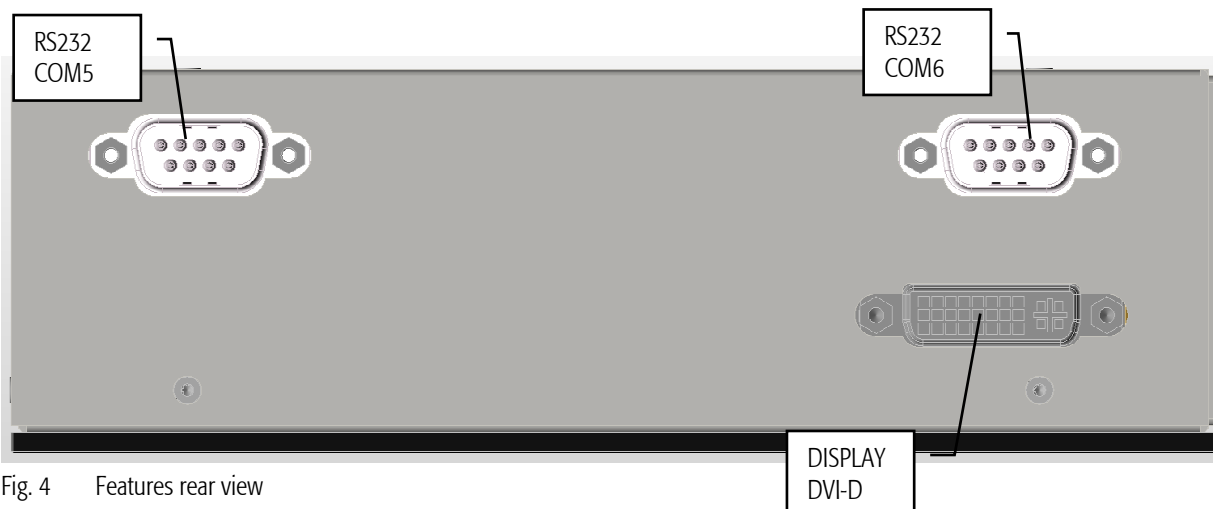

Fig. 4 Features rear view

DOC/IPC\_M8-E; V1.2

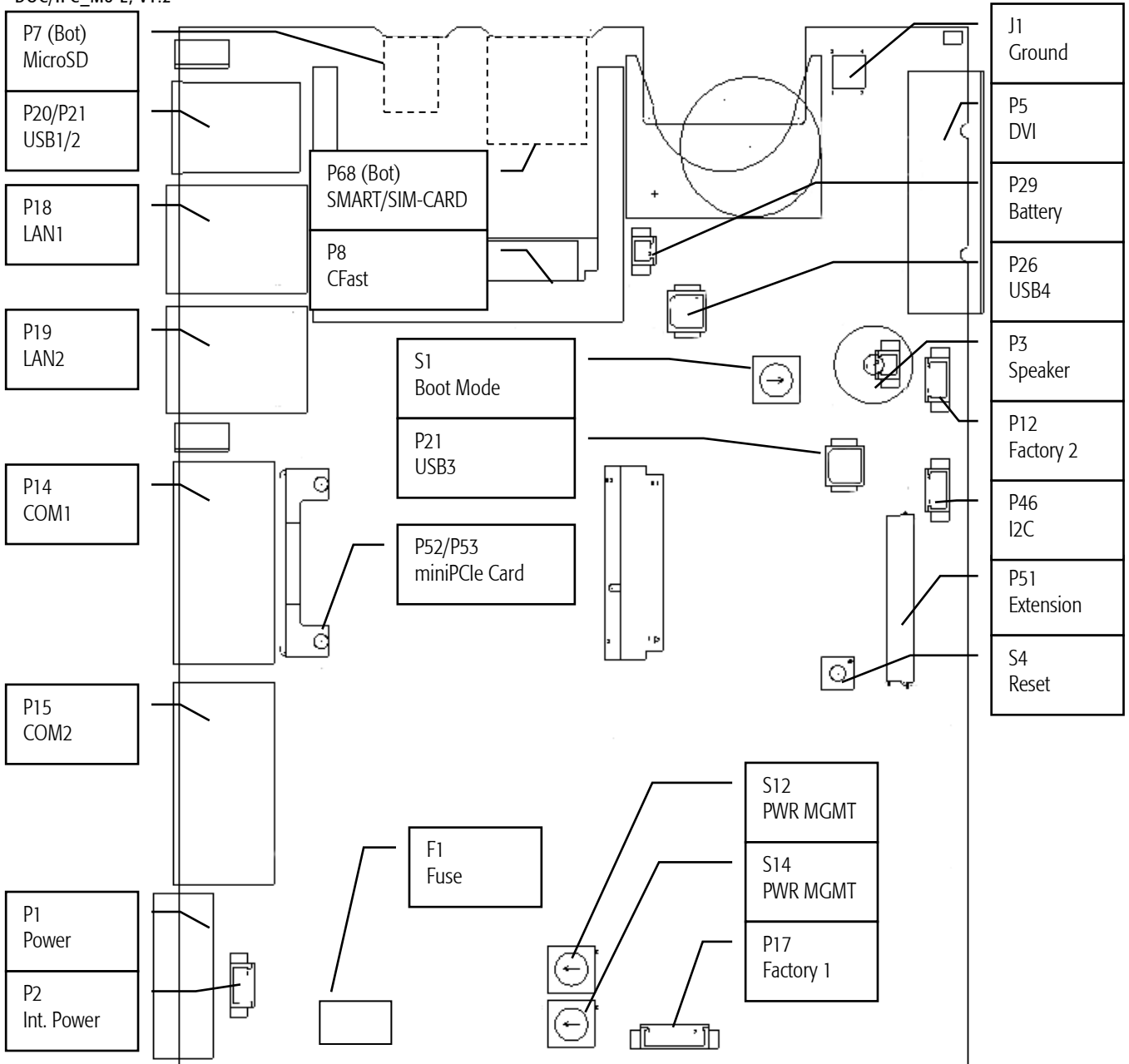

Fig. 5 Board Layout Main-Board

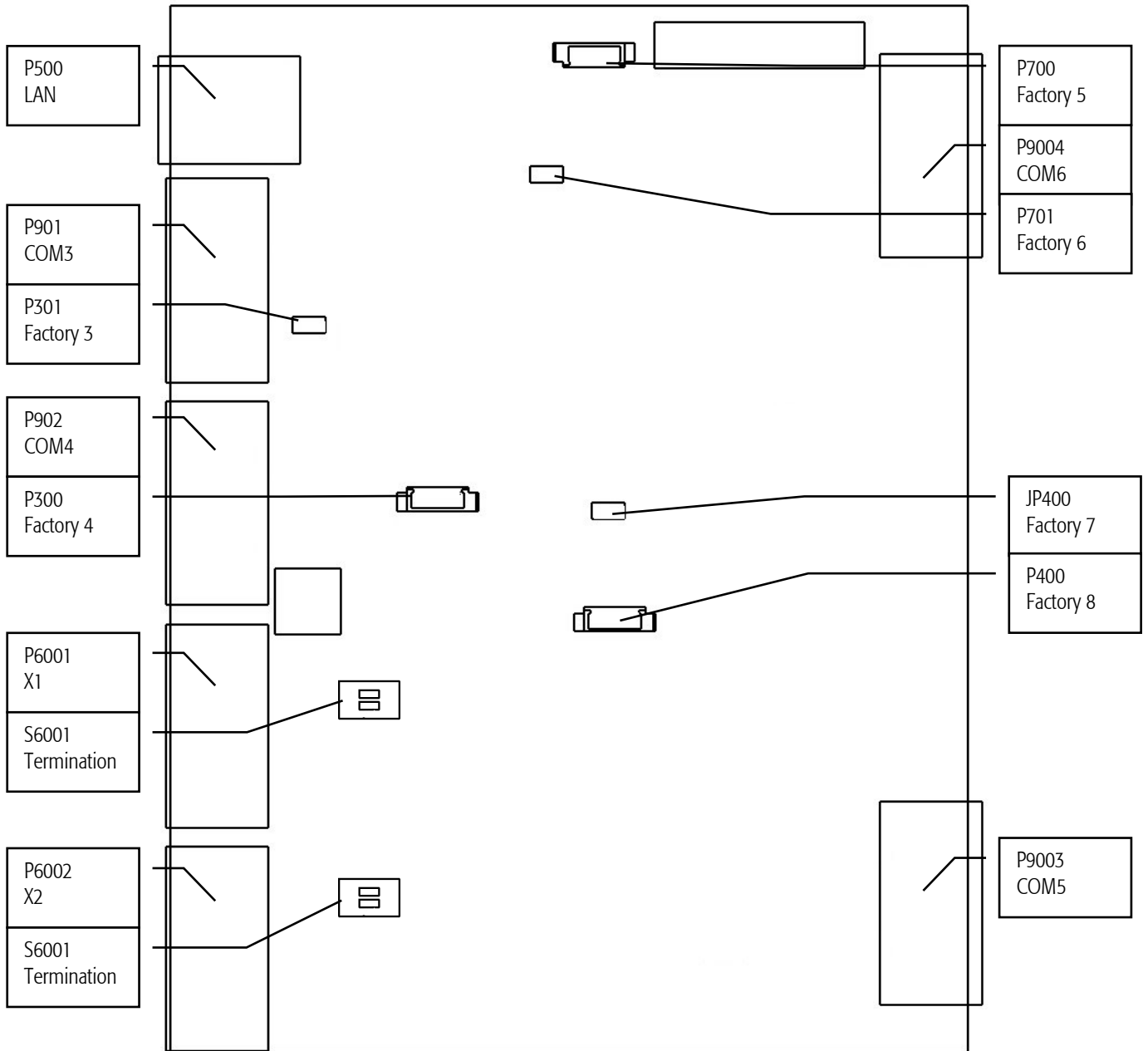

Fig. 6 Board Layout Expansion Board

## 2.5. Memory and I/O Resources

### 2.5.1. General Memory Layout and Configuration

The M8 uses the same memory layout as a standard desktop PC. Three onboard devices , DRAM, graphics controller, and BIOS, make use of the 4 Gbyte (32-bit mode) / 64Gbyte (64-bit mode) adressable memory space.

Address	Device / Register	Remarks
0000'0000..0009'FFFFH	640 kbyte Main Memory (DRAM)	
000A'0000..000B'FFFFH	VGA Video Memory	
000C'0000..000F'FFFFH	Configurable memory range (BIOS, BIOS Extensions, DRAM or redirected to PC/104 bus)	
0010'0000.. FFFF'FFFFH	2-4 Gbyte Main Memory (DRAM)	including graphics memory (UMA)
0000'0001'0000'0000.. 0000'0001'FFFF'FFFFH	optional 4 Gbyte Main Memory (DRAM)	64-bit mode only
0000'0002'0000'0000.. 0000'000F'FFFF'FFFFH	up to top	64-bit mode only

Tab. 4 Physical Memory Address Space Layout

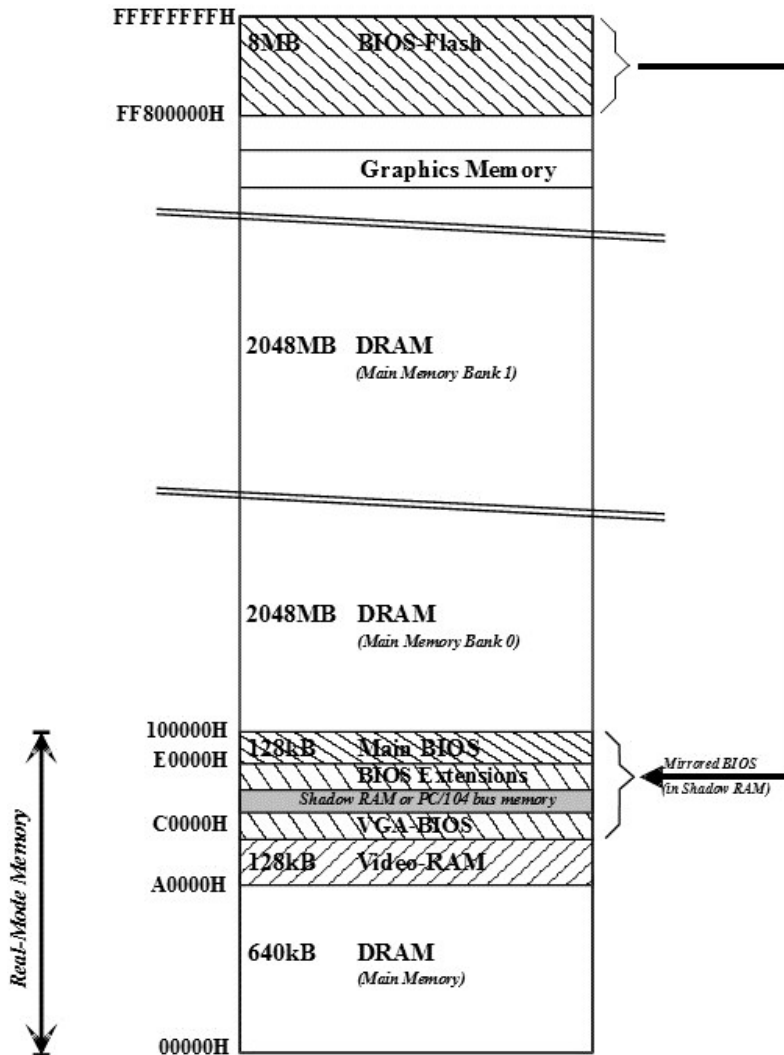

Fig. 7 Memory Map

### 2.5.2. General I/O Layout and Configuration

The M8's 64 kbyte I/O address space is mapped to the PC/104 bus address space as indicated in the table below. Note that 16 bit address decoding should be used on all PC/104 expansion boards to make efficient use of the I/O address space.

Address	Device / Register	Remarks
0000..001FH	DMA Controller 1	
0020..0021H	Master Interrupt Controller	
0022H	Configuration Address Register	
0023H	Configuration Data Register	
0024..003FH	reserved	
0040..0043H	Timer/Counter	
0044..005FH	reserved	
0060H	Keyboard/Mouse Controller	
0061H	Port B Register	
0062..0063H	reserved	
0064H	Keyboard/Mouse Controller	
0065..006FH	reserved	
0070H	Bit 6..0 = RealTimeClock/CMOS-RAM Address Register Bit 7 = Non Maskable Interrupt (NMI) Mask (write only)	
0071H	RealTimeClock/CMOS-RAM Data Register	
0072..007FH	reserved	
0080..0091H	DMA Page Registers / reserved	
0092H	Port 92h System Control Register	
0093..009FH	reserved	
00A0..00A1H	Slave Interrupt Controller	
00A2..00BFH	reserved	
00C0..00DFH	DMA Controller 2	
00E0..010FH	reserved	
0110..016FH	reserved	
0170..0177H	Secondary IDE Channel	
0178..01EFH	reserved	
01F0..01F7H	Primary IDE Channel	
01F8..01FFH	reserved	
0200..026FH	not used	
0278..027FH	reserved for Parallel Port (LPT2) and Plug'n Play	
0280..02E7H	reserved	
02F0..02F7H	reserved	
02F8..02FFH	Serial Port (COM2)	
0300..036FH	not used	
0370..0377H	reserved for external Secondary Floppy Controller	
0376..0377H	reserved for external Secondary IDE Channel	
0378..037FH	Parallel Port (LPT1)	
0380..03AFH	reserved	
03B0..03BBH	VGA registers (MDA)	
03BC..03BFH	reserved for Parallel Port (LPT3)	
03C0..03CFH	VGA registers (EGA)	
03D0..03DFH	VGA registers (CGA)	
03E0..03E7H	reserved	
03F0..03F7H	reserved for external Primary Floppy Controller	
03F6..03F7H	Primary IDE Channel	
03F8..03FFH	Serial Port (COM1)	
0400..042FH	reserved	
0430..04EFH	reserved	
0480..048FH	DMA High Page Registers / reserved	
0490..049FH	Instruction Counter Registers / reserved	
04A0..04CFH	reserved	
04D0..04D1H	IRQ Edge/Level Control	
04D2..04FFH	reserved	
0500..08FFH	reserved	
0900..0A77H	reserved	
0A78H	Plug'n Play configuration port	
0A79..0BFFH	reserved	
0C00..0CF7H	reserved	
0CF8..0CFFH	PCI configuration registers	
0D00..0FFFH	reserved	
1000..3FFFH	reserved	
4000.. 46E7H	reserved	
46E8H	reserved	
46E9..47FFH	reserved	



## DOC/IPC\_M8-E; V1.2

4800..6FFFH	reserved
7000..7FFFH	not used
8000..81FFFH	reserved
8200..821FH	M8 system registers
8220..83FFFH	reserved for Syslogic IPC add-on boards
8400..BFFFH	reserved
C000..CFFFH	reserved for PCI devices (VGA, Ethernet, USB, SATA)
D000..D007H	Serial Port (COM3)
D008...D00FH	Serial Port (COM4)
D010..D01FH	Serial Port (COM5)
D018..D01FH	Serial Port (COM6)
D020..FFFFH	reserved for PCI devices (VGA, Ethernet, USB, SATA)

Tab. 5 I/O Address Space Layout

The processor module on the M8 board offers a JTAG interface for factory operations on the internal header P11. These pins must not be connected by the user.

Pin Number	Signal	Remarks
1	TCK (do not connect)	
2	TDO (do not connect)	
3	TDI (do not connect)	
4	TMS (do not connect)	
5	TRST (do not connect)	
6	GND (do not connect)	

Tab. 6 Factory Programming Header P11 (1x6 pin)

The programmable logic device on the M8 board is factory programmed using some pins of the internal header P12. These pins must not be connected by the user.

Pin Number	Signal	Remarks
1	TCK (do not connect)	
2	TDO (do not connect)	
3	TMS (do not connect)	
4	TDI (do not connect)	

Tab. 7 Factory Programming Header P12 (1x4 pin)

The power management controller on the M8 board is factory programmed using the internal header P17. This header must not be connected by the user.

Pin Number	Signal	Remarks
1	VPP/MCLR# (do not connect)	PICkit3 pin 1
2	VCC (do not connect)	PICkit3 pin 2
3	GND (do not connect)	PICkit3 pin 3
4	PGD (ICSPDAT, do not connect)	PICkit3 pin 4
5	PGC (ICSPCLK, do not connect)	PICkit3 pin 5
6	PGM LVP (SCL, do not connect)	PICkit3 pin 6
7	-- (SDA, do not connect)	--

Tab. 8 Factory Programming Header P17 (1x7 pin)

## 2.6. Peripheral Devices

### 2.6.1. DVI Interface

The DVI-D signals are available on the High Density DVI-D connector P5 for direct connection of DVI-D Single Link compatible monitors. The controller uses the standard VGA register interface. All configurations is done by software (BIOS, VGA-BIOS, OS driver).

#### Device Connection

Pin Number	Signal	Remarks
1	DATA#2	TMDS Link 1 Digital Red
2	DATA2	TMDS Link 1 Digital Red
3	Shield 2/4	connected to Ground
4	DATA#4	TMDS Link 2 not supported
5	DATA4	TMDS Link 2 not supported
6	DDC_CLK	DDC Clock
7	DDC_DATA	DDC Data
8	VSYNC	Analog VGA not supported
9	DATA#1	TMDS Link 1 Digital Green
10	DATA1	TMDS Link 1 Digital Green
11	Shield 1/3	Connected to Ground
12	DATA#3	TMDS Link 2 not supported
13	DATA3	TMDS Link 2 not supported
14	VCC5	+5Vdc standby power for monitor
15	GND	Ground
16	HPDET	Hot Plug Detect
17	DATA#0	TMDS Link 1 Digital Blue
18	DATA0	TMDS Link 1 Digital Blue
19	Shield 0/5	connected to Ground
20	DATA#5	TMDS Link 2 not supported
21	DATA5	TMDS Link 2 not supported
22	Shield CLK	connected to Ground
23	CLK	TMDS Clock
24	CLK#	TMDS Clock
C1	VGA_RED	Analog VGA not supported
C2	VGA_GREEN	Analog VGA not supported
C3	VGA_BLUE	Analog VGA not supported
C4	HSYNC	Analog VGA not supported
C5	VGA_GND	Analog VGA not supported

Tab. 9 DVI-D connector P5 (DSUB15HD)

#### Important Note

Maximum cable length for DVI-D connection is dependent on pixel clock frequency (about 5 m for 1920x1200 resolution). Use high quality shielded DVI-D cables (with twisted diff pair wires for TMDS signals) for maximum EMI protection.

### 2.6.2. Buzzer Interface / Buzzer (optional)

A standard buzzer interface is available on internal connector P3 for connection of a PC buzzer like TDK SD1209T5-A1 or similar type. The buzzer drive signal is generated by the standard PC timer 1. It is buffered by an open collector NPN transistor and protected by a free-wheeling diode against inductive load spikes.

Optionally the buzzer interface can be replaced by a buzzer directly on board.

#### Internal Buzzer

If using an internal buzzer use 2048Hz beep for highest sound level.

## Device Connection

Mating connector type: Housing Molex 51021-0200, Crimp contact Molex 50058-8100.

Wiring: AWG26.

Pin Number	Signal	Remarks
1	BUZ+ (5V)	not fused
2	BUZ- (buzzer drive signal)	100mA max

Tab. 10 Buzzer interface connector P3

### Important Note

This interface is intended for case internal use only.

### 2.6.3. CFast-Interface

The M8 features an SATA generation 2 hostcontroller having assigned the base address and IRQ at boot time by the PCI-BIOS.

Channel 0 of the SATA controller serves the CFast socket

Tested CFast cards are:

- Cactus Technologies KC-series

### Device Connection (CFast)

Pin Number	Signal	Pin Number	Signal
S1	SGND	PC1	CDI
S2	RxP	PC2	GND
S3	RxN	PC3	nc
S4	SGND	PC4	nc
S5	TxN	PC5	nc
S6	TxP	PC6	nc
S7	SGND	PC7	GND
		PC8	LED1
		PC9	LED2
		PC10	IO1
		PC11	IO2
		PC12	IO3
		PC13	PWR
		PC14	PWR
		PC15	PGND
		PC16	PGND
		PC17	CDO

Tab. 11 CFast Connector P8 (SATA Channel 0)

### Important Note

Do not insert or remove the CFast card when power supply is on. This interface does not support hot-plugging.

### 2.6.4. Serial Ports

Up to six serial ports are available on the M8 system. With standard RS232 signals there are four available on standard DSUB-9 connectors at the front (COM1 to COM4) and two are available on standard DSUB-9 connectors on the rear (COM5 and COM6).

### UART Configuration

The M8 Device uses different UARTS to provide the serial ports. COM1 and COM2 are provided by SMSC SCH3112. COM3 to COM6 are provided by Pericom PI7C9X7954. The IO resource of the port COM3 to COM6 is defined during startup and may change according to other hardware. Therefore, it recommended using the PERICOM driver to ensure the access to the serial ports.

For details on serial port setup refer to Tab. 12.

COMPORT	Device Label	Interface	UART, Uart Nbr	IO Address	IRQ	Remark
COM1	COM1 (RS232)	RS232 DSM09	SMSC SCH311x UART1	0x3F8	4	
COM2	CON2 (RS232)	RS232 DSM09	SMSC SCH311x UART2	0x2F8	3	
		RS232 DSM09	SMSC SCH311x UART3 -6	-	-	Disable this ports
COM3	COM3 (RS232)	RS232 DSM09	Pericom PI7C9X7954 UART1	0xa000	19	Not fixed IO/IRQ. Use driver
COM4	COM4 (RS232)	RS232 DSM09	Pericom PI7C9X7954 UART2	0xa008	19	Not fixed IO/IRQ. Use driver
COM5	COM5 (RS232)	RS232 DSM09	Pericom PI7C9X7954 UART3	0xa010	19	Not fixed IO/IRQ. Use driver
	X1 (RS485)	RS485 DSM09				
COM6	COM6 (RS232)	RS232 DSM09	Pericom PI7C9X7954 UART4	0xa038	19	Not fixed IO/IRQ. Use driver
	X2 (RS485)	RS485 DSM09				

Tab. 12 Serial Port setup

The serial Ports COM1 to COM4 are RS232 Ports only located on the front of the device.

The serial Ports COM5 and COM6 are available in different variants. RS232 Interfaces are located on the rear side (COM5, COM6) and RS422/RS485 interfaces are located on the front side (X1, X2). Refer to section 2.2. to review what interfaces are available.

### Configuring COM1 to COM2

These ports can be configured in BIOS and have fixed base addresses. The UART2 to UART6 on the SMSC SCH311x should be disabled in BIOS to not confuse the operating system.

### Configuring COM3 to COM6

Normally there is no need reconfigure the serial ports. Anyway, to reconfigure Serial Port settings refer to device manager (Windows) or ask Syslogic support for configuration tool (Debian).

### Serial Port RS232 Pinout

Pin Number	Signal	Pin Number	Signal
1	DCD	6	DSR
2	RXD	7	RTS
3	TXD	8	CTS
4	DTR	9	RI
5	GND		

Tab. 13 Serial Ports RS232 COM1-COM6 (DSUB-9 male)

### Serial Port RS485 HD

Pin Number	Signal	Pin Number	Signal
1	NC	6	NC
2	NC	7	NC
3	DATA-	8	DATA+
4	DTR*	9	RI*
5	GND		

Tab. 14 Serial Ports RS485 Half Duplex configuration on X1, X2 (DSUB-9 male)

### Serial Port RS485 FD

Pin Number	Signal	Pin Number	Signal
1	NC	6	NC
2	TX-	7	TX+
3	RX-	8	RX+
4	NC	9	NC
5	GND		

Tab. 15 Serial Ports RS485 Half Duplex configuration on X1, X2 (DSUB-9 male)

### Serial Port RS422

Remark on RS422:

RS422 enables the transmitter all the time. RS485 Full duplex enables the transmitter only if data is transmitted.

Pin Number	Signal	Pin Number	Signal
1	Nc	6	NC
2	TX-	7	TX+
3	RX-	8	RX+
4	NC	9	NC
5	GND		

Tab. 16 Serial Ports RS422 configuration on X1, X2 (DSUB-9 male)

### 2.6.5. RS485 FD/RS422 Termination

If required 120Ohm termination can be enabled using internal switches.

Port	Switich	State	Signal
X1	S6001-1	On	COM5 termination on TX line active
X1	S6001-1	Off	COM5 termination on TX line not active
X1	S6001-2	On	COM5 termination on RX line active
X1	S6001-2	Off	COM5 termination on RX line not active
X2	S6002-1	On	COM6 termination on TX line active
X2	S6002-1	Off	COM6 termination on TX line not active
X2	S6002-2	On	COM6 termination on RX line active
X2	S6002-2	Off	COM6 termination on RX line not active

Tab. 17 RS485 FD and RS422 termination

### 2.6.6. RS485 HD Termination

If required 120Ohm termination can be enabled using internal switches.

Port	Switich	State	Signal
X1	S6001-1	On	COM5 termination RS485 line active
X1	S6001-1	Off	COM5 termination RS485 line not active
X1	S6001-2	Any	Not used
X2	S6002-1	On	COM6 termination RS485 line active
X2	S6002-1	Off	COM6 termination RS485 line not active
X2	S6002-2	Any	Not used

Tab. 18 RS485 HD termination

### 2.6.7. USB Interface

The M8 features an OHCI/EHCI and a XHCI compatible USB host controller having assigned the base address and IRQ at boot time by the PCI-BIOS. All ports support USB 2.0 devices and port 1 supports USB 3.0 devices with Superspeed.

#### Device Connection

The USB interface uses a standard A type double USB connector on the front for USB ports 1 and 2. Ports 3 and 4 are located on two internal 4 pin connectors. Port 5 is used for miniPCIe and Port 6 is connected to P50 Expansion header.

Mating connector type for P22, P26: Housing Harwin DataMate M80-8880405, Crimp contacts included (M80-0130005). Recommended wire type: BS3G210 type A, PTFE insulated, 24-28AWG, max insulation diameter 1.10mm. Twist D+/D- wires.

P20 bottom Pin Number	USB port 1 Signal	P20 top Pin Number	USB port 2 Signal
1	VBUS	1	VBUS
2	D-	2	D-
3	D+	3	D+
4	GND	4	GND

Tab. 19 USB1/2 Interface Connector P20 (Dual Type A)

Pin Number	Signal	Remarks
1	D+	
2	D-	
3	VBUS	
4	GND	

Tab. 20 USB4/5 Interface Connector P22 and P26 (2x2pin)

### Important Note

Maximum cable length allowed for USB connection is 3 m. If longer cables are used, special overvoltage and filtering elements have to be installed to comply with the requirements of EMI/RFI "CE"-certification. Only use high quality industrial USB devices with sufficient EMI compatibility.

Use shielded cables for maximum EMI protection.

Drawing excessively power might disturb operation.

### 2.6.8. Ethernet LAN Interface

The M8 features up to three PCI Ethernet controller having assigned the base address and IRQ at boot time by the BIOS. The Ethernet interface drives two LED's (yellow and green) integrated into the RJ45 connector for status information. The meaning of the LED activity is programmable (normally set by the low level driver).

LAN1 to LAN3 feature Intel I210 Ethernet controllers supporting 10/100/1000Mb/s. All interfaces support Auto Negotiation and Auto MDIX functions. Check manufacturer's datasheets for detailed information.

No hardware configuration options are available for the Ethernet device.

### Device Connection

The Ethernet interfaces use the standard RJ45 Gigabit connector P18 and P19 on the front for 100Ω shielded or unshielded Twisted Pair cabling.

Pin Number	Signal	Remarks
1	MD0+	
2	MD0-	
3	MD1+	
4	MD2+	
5	MD2-	
6	MD1-	
7	MD3+	
8	MD3-	

Tab. 21 Ethernet Twisted Pair Interface Connector P18 and P19 (RJ45)

### 2.6.9. CAN Interface

The M8 features two CAN Interfaces with galvanic isolation.

The CAN Controller are identical to the PEAK PCAN miniPCIe with one or two channels.

### Important Note

For detailed information and configuration options of the CAN Controller please refer to the appropriate documentation from PEAK System.

### Remark on Driver support CAN

Current Debian Kernel supports CAN Interface. Make sure the Networking Driver for "PEAK PCAN-PCI/PCIe/miniPCI Cards" is included in your Kernel. This allows you to use the CAN Interface as a networking device.

Furthermore PEAK System offer a proprietary driver that can be installed for character device (CHARDEF) and networking (NETDEF) device support.

### Device connections

The M8 has a DSUB9 connectors for each CAN channel.

Device Label	Internal Connector	Interface
X1	P6002	CAN1 (first CAN Interface)
X2	P6002	CAN2 (second CAN Interface)

Tab. 22 CAN Interfaces

Pin	Signal Designation	Signal
1	-	not used
2	CAN_L	CAN_L
3	CAN_GND	signal ground
4	-	not used
5	-	not used
6	-	not used
7	CAN_H	CAN_H
8	-	not used
9	-	not used

Tab. 23 Pin assignment of CAN interface: X1 at P30 / X2 at P31

CAN Termination (120  $\Omega$ ) is not as a factory default. It can be enabled using internal switch. Refer to Fig. 6

Port	Switich	State	Signal
X1	S6001-1	Any	Not used
X1	S6001-2	On	CAN1 termination active
X1	S6001-2	Off	CAN1 termination not active
X2	S6002-1	Any	Not used
X2	S6002-2	On	CAN2 termination active
X2	S6002-2	Off	CAN2 termination not active

Tab. 24 CAN Termination settings

If fixed termination is required, contact manufacturer please (refer to chapter 8.2)

### 2.6.10. I2C Interface

The M8 features one I2C interface on an internal connector. The interface is integrated into the processor module (see processor module datasheet for details). The signals are non-buffered 3.3V LVCMOS interfaces with integrated pullups.

Consult processor module datasheet for programming details.

#### Device Connection I2C

The first I2C interface uses connector P46. Mating connector type: Housing Molex 51021-0400, Crimp contact Molex 50058-8100. Wiring: AWG26.

Pin Number	Signal	Remarks
1	VCC (3.3V)	not fused!
2	SDA	3.3V LVCMOS with integrated pullup
3	SCL	3.3V LVCMOS with integrated pullup
4	GND	

Tab. 25 I2C Interface Connector P46

#### Important Note

This interface is intended for case internal use only.

### 2.6.11. Watchdog

The watchdog timer is configurable for 100 ms or 1 s base (default) timeout. Longer timeouts may be achieved by programming the Watchdog Configuration Register.

Once timed out, it may activate the M8 hardware reset or the processors NMI line depending on software configuration.

### Configuration Options

Switch	Configuration	Remarks
S1	even positions '0', '2', '4', '6', '8' = 1 s odd positions '1', '3', '5', '7' = 100 ms	see Tab. 3. see Tab. 3.

Tab. 26 Watchdog Configuration Options

### 2.6.12. Power supply

The processor and its peripherals are powered by a non-isolated, integrated power supply which generates all the necessary voltages.

The power must be connected using the following mating connector:

- CPN/BLWBCZ38-4FSW (*Weidmueller BCZ 3.81/04/180F SN SW Ordercode 1792970000*).

The mating connector can be ordered directly at Syslogic or at local Weidmueller distributor.

Pin Number	Signal	Remarks
1	+24VDC_AUX	Auxiliary power supply
2	Power Fail/Remote on/off	Power fail input
3	+24VDC	
4	GND	

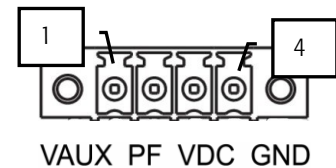

Fig. 8 Power supply connector

Tab. 27 Power supply connector

For normal operation the external power supply has to be connected to the pins 3 (+24VDC) and 4 (GND) of the connector.

Pin 1 (+24VDC\_AUX) may be used as a standby supply for the optional GoldCap RTC backup.

Pin 2 is used as an input for either a power fail or remote on/off signal.

### 2.6.13. Power supervision

The power management control unit (PCU) can be operated in two modes: power fail mode or remote on/off mode. The following two chapters describe their functionality in detail.

Switch	Configuration	Remarks
S12	position '0' = test mode (powerfail active) position '1' = internal pulldown (remote on/off mode) position '2' = internal pullup (power fail mode) position '3' to 'F' = reserved (do not use)	check chapter 2.6.14/2.6.15

Tab. 28 Power fail input configuration

Switch	Configuration	Remarks
S14	position '0' = bypass mode (for power fail mode) position '1' to 'F' = remote on/off mode	check chapter 2.6.14/2.6.15

Tab. 29 Power fail mode configuration

### 2.6.14. Power Fail

In power fail mode the microcontroller monitors the external power fail signal. The state of power fail signal can be access through the status register, I/O 8200h.



### Application example

Fig. 9 Typical power fail application

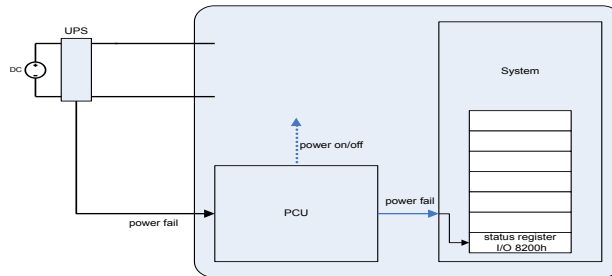

The application has to poll the power fail flag and call different functions according to the state of the flag.

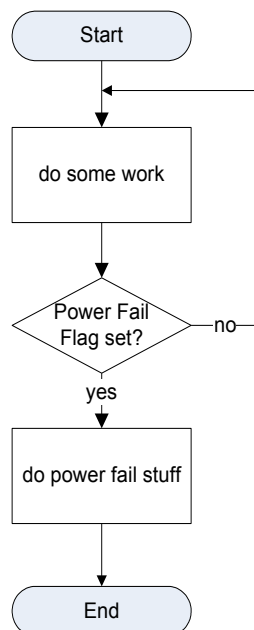

Fig. 10 Typical power fail flow

#### 2.6.15. Remote On/Off

With the remote on/off function the system can be switched on and of through an external control signal. When active the internal software goes from the run state into the shutdown state. After a predefined timeout the PCU switches the main power supply off. The timeout can be configured through S14.

Config switch S14 position	t <sub>debounce_on</sub> On debouncing (setup)	t <sub>debounce_off</sub> Off debouncing (hold)	t <sub>startup</sub> Hold time until switch off signal is routed to processor, if system is still booting	t <sub>hard_off</sub> Timeout until switch off signal is generated from processor (after that hard off)
0	-	-	-	-
1	2 s	60 s	5 s	1 min
2	2 s	60 s	60 s	5 min
3	2 s	60 s	30 min	2 h
4	2 s	60 s	2 h	2 h
5 – F	N/a	n/a	n/a	n/a

Tab. 30 PCU timing configuration through S14

When switch S14 is in position 0 the PCU is in bypass mode.

**Application example**

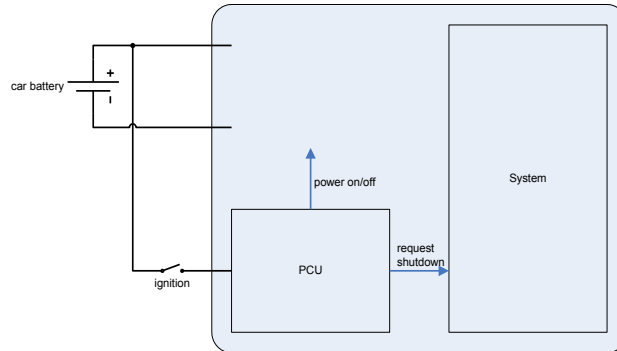
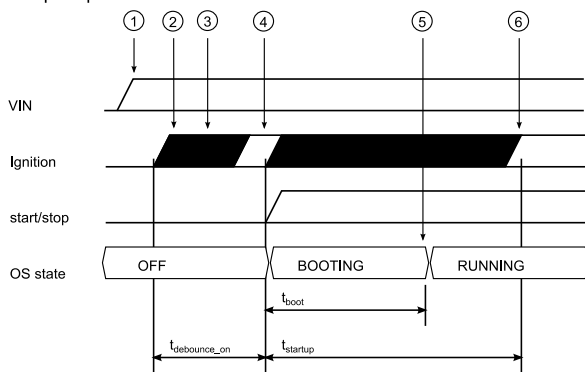

Fig. 11 Application example: CAR PC

Startup sequence



Notes:

- 1) VIN supply must be present
- 2) Ignition on starts debouncing sequence
- 3) glitches/bounces are ignored during  $t_{debounce\_on}$
- 4) if ignition signal is stable after  $t_{debounce\_on}$  supply is switched on and the system starts
- 5) during  $t_{startup}$ , ignition switch is ignored  
Note: system might have finished booting well in advance before startup phase is over
- 6) after  $t_{startup}$ , the power management circuit resumes tracking of the ignition switch signal

Fig. 12 Startup timing diagram

Forced shutdown sequence

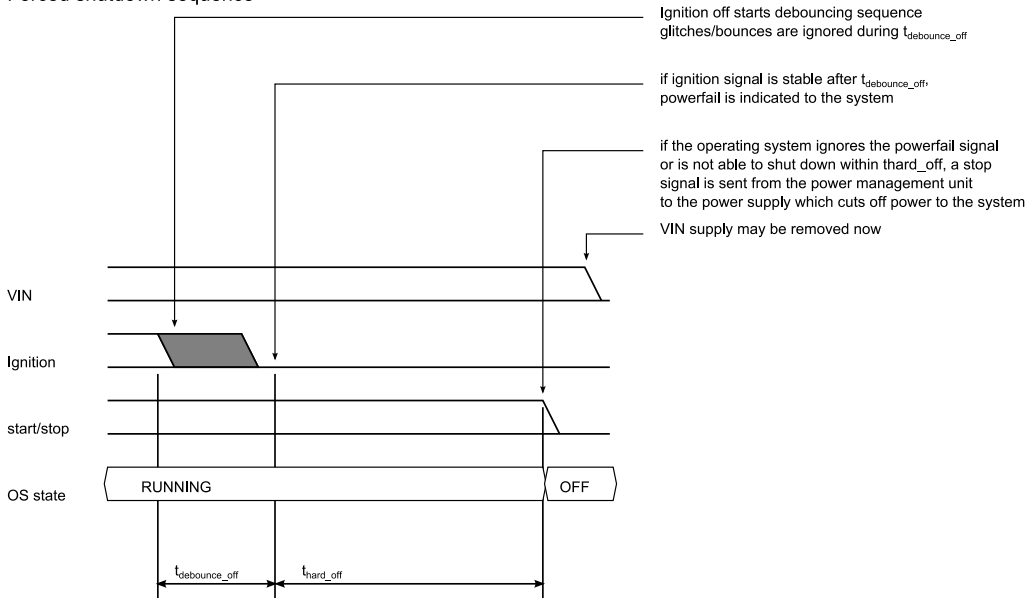

Fig. 13 Shutdown timing diagram

**Important Notes**

The operating system must support the remote on/off function.

### 2.6.16. Front Side Status LEDs

The two colored LEDs on the front side show the following states:

LED	Signal	Remarks
Red up	STOP signal	For programming information refer to Control register in chapter 4
Green down	Board ready	For programming information refer to Setup register in chapter 4

Tab. 31 Front side LED

### 2.6.17. Ground-Shield connection

The M8 provides a jumper to connect the internal ground to the case (shield). The jumper is located left of the battery and is accessible if the service cover is opened.

LED	Jumper setting	Remarks
Open	1-3, 2-4	Shield and internal ground are separated (default)
Connected	1-2, 3-4	Shield and internal ground are connected.

Tab. 32 Ground shield connection

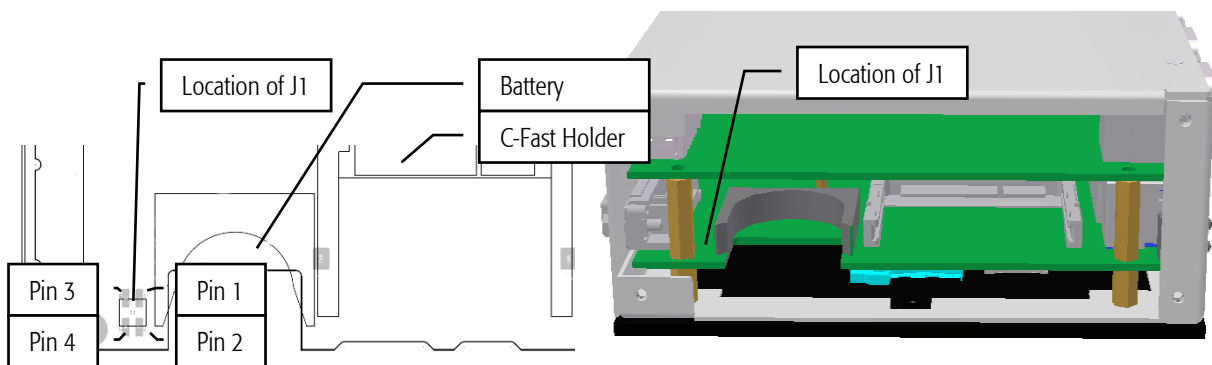

Fig. 14 J1 Ground-Shield connection

## 3 Programming Information

### 3.1 Overview

The programming of the M8 board is done with standard memory and I/O read and write operations. Most configuration options are handled by the BIOS. For detailed information refer to the NETIPC firmware documentation and other related documents as listed in paragraph 7.

Please contact Syslogic technical support if you need special BIOS configuration.

### 3.2 Interrupt, Memory and I/O Resources

#### 3.2.1 Interrupt Resources

The following table shows the usage of the interrupt resources. Interrupts marked 'shared' are shared between an onboard device and an PC/104 bus interrupt line. These interrupts should only be used for multiple interrupt sources, if all interrupt routines are able to process shared interrupts. Interrupts marked 'free' are not used by onboard devices if they are not assigned to a PCI device in the BIOS configuration. Interrupts for use on the PC/104 bus must be configured as 'reserved' in CMOS setup legacy interrupt configuration and must not be used by SIO peripherals (check SIO configuration in CMOS setup).

Interrupt	Interrupt Source	Remarks
<b>Master</b>		
IRQ0	Timer Channel 0	
IRQ1	PS/2-Controller (Keyboard)	SIO, check CMOS setup
IRQ2	Slave Interrupt Controller Cascading	
IRQ3	COM2	SIO, check CMOS setup
IRQ4	COM1	SIO, check CMOS setup
IRQ5	available for PCI or COM4	SIO, check CMOS setup
IRQ6	available for PCI or PC/104 Bus IRQ6	check CMOS setup
IRQ7	available for PCI or LPT1	SIO, check CMOS setup
<b>Slave</b>		
IRQ8	Real Time Clock	
IRQ9	ACPI/PCI	do not connect
IRQ10	available for PCI or COM3	SIO, check CMOS setup
IRQ11	available for PCI Bus IRQ11	check CMOS setup
IRQ12	available for PCI or PS/2-Controller	SIO, check CMOS setup
IRQ13	Floating Point Unit	
IRQ14	Primary IDE/SATA Channel in legacy mode	do not connect
IRQ15	available for PCI Bus IRQ15	check CMOS setup
<b>Special</b>		
NMI	Watchdog and PC/104 Bus Error Interrupt IOCHCK*	shared

Tab. 33 Interrupt Usage

### 3.2.2. Memory Resources

The general memory layout is shown in paragraph 2.5.1. The configuration of the memory layout is done by programming processors internal configuration registers and board configuration registers (see paragraph 3.2.3). This is done completely by the BIOS on system startup and must not be changed during operation. For operating systems requiring memory configuration (e.g. Windows CE) the memory layout shown in paragraph 2.5.1 must be considered.

### 3.2.3. I/O Resources

This paragraph describes only the M8 system registers and support functions not directly related to a specific peripheral device. The general I/O layout is shown in paragraph 2.5.2. Peripheral devices are discussed in paragraph 0. Note that the Socket Memory related registers are programmed by the BIOS on system startup and must not be changed during operation.

Address	Device / Register	Remarks
8200H	Status Register	
8201H	Control Register	Reset state = 05H
8202H	Function ID Register	
8203H	Watchdog Configuration Register	Reset state = 80H
8204H	Option ID Register	
8205H	Setup Register	Reset state = 00H
8206H	Revision ID Register	
8207H	Socket Memory Configuration Register	not supported
8208H	Socket Memory Window Mapping Register	not supported
8209H	Socket Memory Window Base Address Register	not supported
820AH	Boot Mode Input Register	
820BH	I2C Register for Temp Sensor	
820CH	Configuration Switch Input register	
820DH	PWM-Register for LCD Inverter Brightness Control	Reset state = FFH
820E..821FH	reserved	do not access

Tab. 34 M8 System Registers

## Status Register 8200h

D7	D6	D5	D4	D3	D2	D1	D0	Access
OVRTMP#	LOBAT#	1	WDG#	ERRFLG#	ATTFLG#	ERRINT#	ATTINT#	Read
reserved								Write
1111'1111 (0xFF)								Reset

Description:

OVRTMP# Temperature Sensor Status Flag

Read	Write
0 = programmed temp. limit reached 1 = temperature ok (below limit)	

LOBAT# Battery Status Flag

Read	Write
0 = Battery voltage low 1 = Battery voltage ok	

WDG# Watchdog Status Flag

Read	Write
0 = Watchdog has timed out 1 = Watchdog running or disabled Reset by issuing a hardware reset (see register 8204hex)	

ERRFLG# Error Status Flag (for polled applications)

Read	Write
not used, returns 1	

ATTFLG# Attention Status Flag (for polled applications)

Read	Write
not used, returns 1	

ERRINT# Error Interrupt Status

Read	Write
0 = Error Interrupt pending 1 = No error interrupt pending	

ATTINT# Attention Interrupt Status Flag

Read	Write
not used, returns 1	

Reserved Reserved, always write 0

## Control Register 8201h

D7	D6	D5	D4	D3	D2	D1	D0	Access
TRIG#	WDTRIG	WDNMI	STOP	TRGSRC	FREEZE	ERREN#	ATTEN#	Read
TRIG#	WDTRIG	WDNMI	STOP	TRGSRC	FREEZE	ERREN#	ATTEN#	Write
0000'0101 (05h)								Reset

**Description:**

TRIG#	Bus Trigger (currently not supported)	
	<b>Read</b>	<b>Write</b>
	readback of written value	
WDTRIG	Watchdog Trigger	
	<b>Read</b>	<b>Write</b>
	readback of written value	Any state change triggers the watchdog.
WDNMI	Watchdog NMI Configuration	
	<b>Read</b>	<b>Write</b>
	0 = Watchdog activates hardware reset 1 = Watchdog timeout activates Non Maskable Interrupt (NMI)	0 = Watchdog activates hardware reset 1 = Watchdog timeout activates Non Maskable Interrupt (NMI)
STOP	NETSBC Stop# Signal State	
	<b>Read</b>	<b>Write</b>
	0 = STOP# inactive (high), red LED off 1 = STOP# active (low), red LED on	0 = STOP# inactive (high), red LED off 1 = STOP# active (low), red LED on
TRGSRC	Trigger source selection	
	<b>Read</b>	<b>Write</b>
	not used, returns 0	
FREEZE	Freeze bit	
	<b>Read</b>	<b>Write</b>
	not used, returns 1	
ERREN#	Error Interrupt Enable (PC/104 bus IOCHCK# routed to NMI)	
	<b>Read</b>	<b>Write</b>
	always 0 = Error Interrupt on NMI always enabled	
ATTEN#	Attention Interrupt Enable	
	<b>Read</b>	<b>Write</b>
	not used, returns 1	

The STOP# signal also directly drives the red LED on the front (STOP# low = LED on).

Upon startup STOP# is active (LED on) until the BIOS has initialized the main peripherals, it is set inactive (LED off) before booting the operating system. STOP# is also active (LED on) while operating in Bootloader mode.

## Function ID Register 8202h

D7	D6	D5	D4	D3	D2	D1	D0	Access
FID[7:0] Function ID								Read
reserved, always write 0								Write
same as Read value								Reset

Description:

FID                      Function ID

Read	Write
51h = general IPC processor board	reserved, always write 0

**Watchdog Configuration Register 8203h**

D7	D6	D5	D4	D3	D2	D1	D0	Access
WDLOCK	0	0	0	WDTOUT[3:0] Watchdog Timeout Selection			Read	
WDLOCK	reserved	reserved	reserved	WDTOUT[3:0] Watchdog Timeout Selection			Write	
1000'0000 (80h)								Reset

Description:

WDLOCK                      Watchdog Lock Flag (prevents disabling running Watchdog)

Read	Write
0 = Inactive, not locked 1 = Active, locked	0 = do not lock 1 = lock WDEN

WDTOUT                      Watchdog Timeout Selection

Read	Write
0 = 1s if S1=even, 100ms if S1=odd 1 = 4s 2 = 8s 3 = 16s 4 = 32s 5 = 64s 6 = 128s 7 = 256s	0 = 1s if S1=even, 100ms if S1=odd 1 = 4s 2 = 8s 3 = 16s 4 = 32s 5 = 64s 6 = 128s 7 = 256s

reserved                      Reserved, always write 0

**Note**

Watchdog timeout selection values &gt; 0 are independent of switch S1 setting.



**Option ID Register 8204h**

D7	D6	D5	D4	D3	D2	D1	D0	Access
OID[7:0] Option ID								Read
reserved, always write 0								Write
same as Read value								Reset

Description:

OID                      Option ID

Read	Write
D2h = M8/S8	A5h = Writing data A5h invokes a complete hardware reset (also clearing the Watchdog timeout status bit) 5Ah = Writing data 5Ah invokes a complete power off or power reset (also clearing the Watchdog timeout status bit), system restarts depending on configuration of power management controller.

## Setup Register 8205h

D7	D6	D5	D4	D3	D2	D1	D0	Access
READY	WDEN	AUX	0	0	USBEN2	USBEN1	USBEN0	Read
READY	WDEN	AUX	0	0	USBEN2	USBEN1	USBEN0	Write
0000'0111 (07h)								Reset

Description:

READY Ready bit, green LED

Read	Write
0 = Inactive, green LED off 1 = Active, green LED on	0 = Deactivate green LED 1 = Activate green LED

WDEN Watchdog enable

Read	Write
0 = Watchdog disabled 1 = Watchdog enabled (running)	0 = Disable watchdog 1 = Enable watchdog

AUX Auxiliary LED, green LED

Read	Write
0 = Inactive, green AUX LED off 1 = Active, green AUX LED on	0 = Deactivate green AUX LED 1 = Activate green AUX LED

USBEN2 USB4/5 Power enable

Read	Write
0 = USB5/6 power off 1 = USB5/6 power on	0 = disable USB5/6 power 1 = enable USB5/6 power

USBEN1 USB2/3 Power enable

Read	Write
0 = USB3/4 power off 1 = USB3/4 power on	0 = disable USB3/4 power 1 = enable USB3/4 power

USBEN0 USB0/1 Power enable

Read	Write
0 = USB1/2 power off 1 = USB1/2 power on	0 = disable USB1/2 power 1 = enable USB1/2 power

The READY signal directly drives the green LED on the front (READY high = LED on).

Upon startup READY is inactive (LED off) until the BIOS has initialized the main peripherals, it is set active (LED on) before booting the operating system.

Always read back the current state before programming this setup register for enabling the watchdog!

### Important Note

Be careful when disabling USB power by setting USBENx=0 since this will disable any all devices connected to the two related USB ports. Always use a program sequence which automatically reenables USB power some seconds later.

**Revision ID Register 8206h**

D7	D6	D5	D4	D3	D2	D1	D0	Access
RID[7:0] Revision ID								Read
reserved, always write 0								Write
same as Read value								Reset

Description:

RID                    Logic Design Revision ID

Read	Write
See chapter 8.1	

reserved             Reserved, always write 0

**Socket Memory Configuration Register 8207h**

D7	D6	D5	D4	D3	D2	D1	D0	Access
0	0	0	0	0	0	0	0	Read
reserved								Write
0000'0000 (0x00)								Reset

Description:

Read	Write
0	

Reserved             reserved, do not write

**Socket Memory Window Mapping Register 8208h**

D7	D6	D5	D4	D3	D2	D1	D0	Access
0	0	0	0	0	0	0	0	Read
reserved								Write
0000'0000 (0x00)								Reset

Description:

Read	Write
0	

Reserved             reserved, do not write

**Socket Memory Window Base Address Register 8209h**

D7	D6	D5	D4	D3	D2	D1	D0	Access
0	0	0	0	0	0	0	0	Read
reserved								Write
0000'0000 (0x00)								Reset

Description:

Read	Write
0	

Reserved             reserved, do not write

**Status Register 820Ah**

D7	D6	D5	D4	D3	D2	D1	D0	Access
0	0	0	0	0	0	BM1	BM0	Read
reserved								Write
0000'0011 (0x03)								Reset

Description:

BM1..0 Boot Mode Inputs

Read	Write
0 = reserved 1 = reserved 2 = boot from backup BIOS 3 = normal Operating Mode	

Reserved reserved, do not write

**I2C Register 820Bh for temperature sensor control**

D7	D6	D5	D4	D3	D2	D1	D0	Access
SCLO	SDAO	SCL	SDA	1	1	1	1	Read
SCLO	SDAO	Reserved, always write 1						Write
FFh								Reset

Description:

SCLO Clock Port Output State

Read	Write
0 = Pin state = low 1 = Pin state = high	0 = Output latch state = low 1 = Output latch state = high (open collector)

SDAO Data Port Output Port Latch State

Read	Write
0 = Pin state = low 1 = Pin state = high	0 = Output latch state = low 1 = Output latch state = high (open collector)

SCL Clock Port Pin State

Read	Write
0 = Pin state = low 1 = Pin state = high	

SDA Data Port Pin State

Read	Write
0 = Pin state = low 1 = Pin state = high	

**Configuration Switch Input Register 820Ch**

D7	D6	D5	D4	D3	D2	D1	D0	Access
0	0	0	0	S1-D3	S1-D2	S1-D1	S1-D0	Read
reserved								Write
xxxx'xxxx (0xXX)								Reset

Description:

D3-0 Configuration Switch S1 Inputs

Read	Write
S1 state (0-F)	

D7-4 Configuration Switch Inputs

Read	Write
0 (reserved)	

Reserved reserved, do not write

### 3.3. Peripheral Devices

#### 3.3.1. DVI/LCD-Interface

The DVI/LCD interface uses the standard PC/AT VGA register set. For detailed programming information please refer to the IBM PC/AT Technical Reference or similar documentation.

Low level programming is handled by the VESA compatible VGA-BIOS.

For custom LCD BIOS requirements please contact Syslogic technical support.

For detailed programming information please refer to the Intel Atom E38xx technical reference or similar documentation. Legacy support and low level programming is handled by the BIOS and standard OS drivers.

#### 3.3.2. SATA/CFast-Interface

For detailed programming information please refer to the Intel Atom E38xx technical reference or similar documentation. Legacy support and low level programming is handled by the BIOS and standard OS drivers.

#### 3.3.3. Serial Ports

The Serial Port interfaces use the standard PC/AT register set. The Serial Port controller is compatible with the standard 16C550A UART with 16 byte receive and transmit fifos. For detailed programming information please refer to the IBM PC/AT Technical Reference, the SMSC SCH3116 or Pericom datasheet or similar documentation. Legacy support and low level programming is handled by the BIOS and standard OS drivers.

#### 3.3.4. Ethernet Interface

The Ethernet interfaces use the Intel I210IT Ethernet Controller. For detailed programming information and drivers check [www.intel.com](http://www.intel.com).

#### 3.3.5. USB Interface

The USB interfaces use the standard OHCI/EHCI/XHCI register set. Legacy support and low level programming is handled by the BIOS and standard OS drivers.

#### 3.3.6. CAN Interface

For detailed programming information on CAN Interface refer to PEAK System PCAN miniPCIe module. Driver and programming information can be obtained from PEAK System homepage.

#### 3.3.7. Temperature Sensor

The Temperature Sensor is built up using an LM75 compatible temperature sensor programmable through an I2C interface. The I2C interface programming is done through the I2C Register of the M8. For detailed programming information please refer to the National Semiconductor LM75 datasheet or similar documentation.

Poweron default setting for OVERTMP\* is 80°C chip temperature.

The temperature reading shows an internal temperature. Even with moderate GPU and CPU usage the temperature reading may be 15°C to 20°C above ambient temperature.

### 3.3.8. Watchdog

The watchdog is disabled by default on poweron and must be enabled by the application program.

Before enabling the watchdog by setting the WDEN bit in the M8 Setup Register, the watchdog action (RESET or NMI) must be programmed in the M8 Control Register (bit WDNMI) and the timeout value must be configured using switch S1 and/or the M8 Watchdog Configuration Register.

If RESET activation is selected, the watchdog generates a hardware reset if it is not triggered within the configured timeout window by writing the WDTRIG bit in the M8 Control Register. The application must check the WDG\* bit in the M8 Status Register upon startup to identify the Watchdog as the source of the reset, and it must issue a hardware reset (by writing the value 0a5h to the M8 Option ID Register) to clear the WDG\* flag. Otherwise the system resets again as soon as the Watchdog is started.

If NMI activation is selected, the watchdog generates a Non Maskable Interrupt to the processor if it is not triggered within the configured timeout window by writing the WDTRIG bit in the M8 Control Register. Note that enabling the NMI input of the processor also requires setting bit 7 of I/O port 70h (NMI mask) and clearing bit 3 of I/O port 61h (Port B IOCHK# enable). The NMI routine must check the WDG\* bit in the M8 Status Register to identify the watchdog as the source of the NMI, and it must issue a hardware reset (by writing the value 0a5h to the M8 Option ID Register) to clear the WDG\* flag. Otherwise the NMI routine is entered again as soon as the watchdog is started.

Sample code showing the initialization and triggering of the watchdog is available for RESET and NMI mode in the free IPC/IOCOMSW-1A package.

#### Note

The NMI mask bit (bit 7 of I/O port 70h) is write only. Typically it is enabled by the BIOS and should not be disabled by application software.

## 4 Installation and cabling

### 4.1 Introduction

Installation and cabling of the IPC/M8 system has to be done with great care; the correct cabling is essential for high operational reliability and the correct grounding is necessary for protection. To meet the requirements of "CE"-certification all cables have to be shielded. The enclosure has to be connected to ground via the DIN-rail or mounting kit.

#### Important note

Before applying power to the M8 system, the main board must be configured correctly.

#### Important notes

To meet the requirements of EMI/RFI "CE"-certification, correct mounting, installation and cabling of the M8 system according to these guidelines is absolutely necessary.

### 4.2 Maximum cable length

Interface	Max cable length	Remark
DVI	<30m	Do not connect to cables that lead to the outside. Maximum cable length is depending on resolution and refresh rate of the display data as well as the quality of the cable. Anyway: do not exceed a maximum length of 30m.
USB	<3m	Service Port
Ethernet	<100m	Maximum cable length is influenced by transmission speed
RS232	<30m	Do not connect to cables that lead to the outside.
RS485 (X1,X2)	<100m	Maximum cable length is influenced by transmission speed
CAN (X1, X2)	<100m	Maximum cable length is influenced by transmission speed
Power	<30m	Do not connect to cables that lead to the outside.

Tab. 35 Maximum cable length

#### Important notes

Do not exceed maximum cable length to and follow the instructions given in the table above to fulfill compliance requirements.

### 4.3. Power supply

The use of a power supply with the following requirements is mandatory:

- minimal power: 21W
- voltage range: 9...30Vdc
- efficiency > 88%
- integrated over-current limitation
- compliant with the directives 2004/1008/EC (EMC) and 2006/96/EC (LVD)
- compliant with the standards EN 61000-6-1, EN 61000-6-2, EN 61000-6-3 and EN 61000-6-4, FCC Part 15 Class B
- compliant with EN 60950-1

Syslogic recommends the use of the Syslogic DIN Rail power supply *CPN/ML60-242E* or *PSU/DR24V60W-1P* input voltage: 230Vac, output voltage: 24Vdc, power: 60W.

Please make sure that the input voltage must meet the specification. Refer to Chapter 6.1.

### 4.4. Powering the M8 System

The "logic supply voltage", i.e. the power driving the electronic circuits (CPU and base board) is internally generated from the 12/24VDC power supply input. Remember that the power supply is non-isolated. For an isolated version please contact the manufacturer.

The power supply has to be connected according to paragraph 2.6.12. Maximum allowed cable length between ac/dc power supply and system power input is 30 m. If the cable is longer than 30 m or routed outside the building, special overvoltage and filtering elements have to be installed to comply with the requirements of EMI/RFI "CE"-certification.

When selecting the external power supply the maximum power dissipation of the system has to be considered.

#### Important notes

Please make sure that the input voltage does not exceed the recommended operating range otherwise the electronics board could get damaged and correct operation cannot be guaranteed.

Use an overload protected power supply to prevent damage in case of a short inside the system.

The ac/dc power supply must fulfill the requirements for EMI/RFI "CE"-certification.

### 4.5. Cabling the interfaces

Use appropriate cabling for all interfaces. Shielded cabling is required to meet the EMI/EMC limits.

### 4.6. Grounding

In some cases it is recommended to connect the shields of the cables to chassis potential at the entry point into the housing cabinet as shown in Fig. 15. If the cables enter a hermetically closed cabinet, use special 360 degree metal clamps (EMI/RFI protected types which contact to the cable shield).

#### Important notes

Grounding of the cables shields using "pig-tail wires" are not recommended because of their high impedance at high frequencies. It is better to damp the shields onto a grounded copper rail.



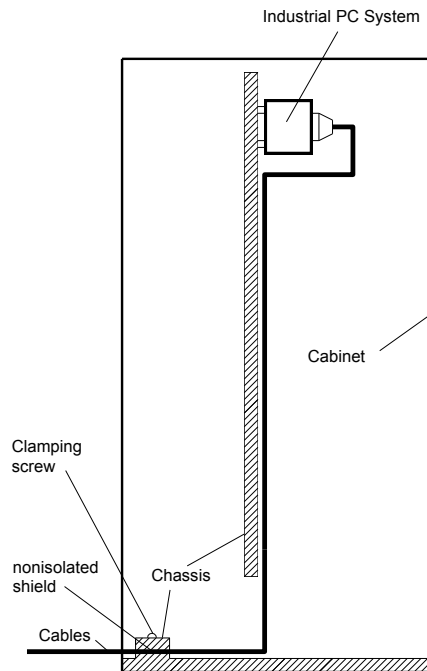

Fig. 15 Additional grounding of the cable shields at the entry point of a cabinet.

### 4.7. Cabling of communication links

If the communication ports are unisolated ports, cable shields have to be connected to chassis potential on both sides of the interconnection cable. If the cable is very long, a thick copper wire (10 mm<sup>2</sup>) for potential adjustment is highly recommended.

Fig. 16 shows an non isolated system with common chassis ground.

Some of the communication ports are galvanically isolated ports. In such cases the shield of the interconnection cable must be wired to chassis potential only on one side of the cable.

Fig. 17 shows an isolated system with independent grounds.

#### Important notes

Grounding of cable shields using "pig-tails wires" are not recommended because of their high impedance at high frequencies. It is recommended to clamp the shields onto a grounded copper-rail.

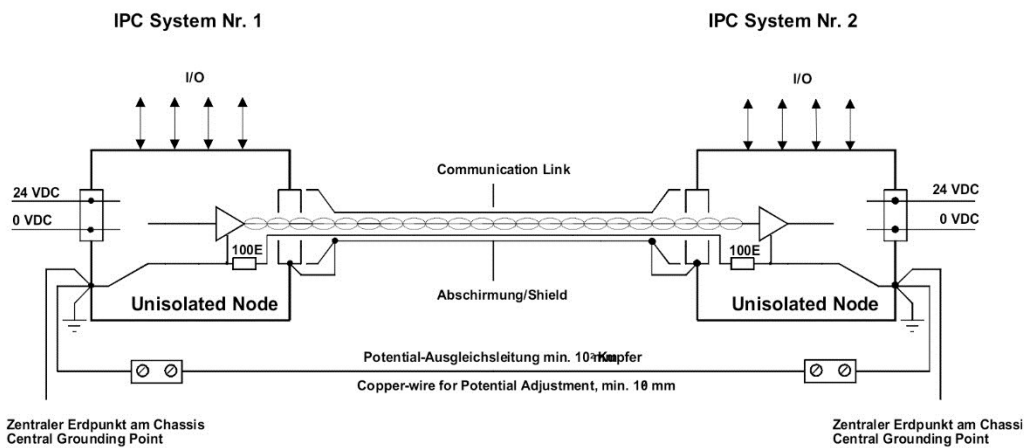

Fig. 16 Non isolated communication link with common chassis potential

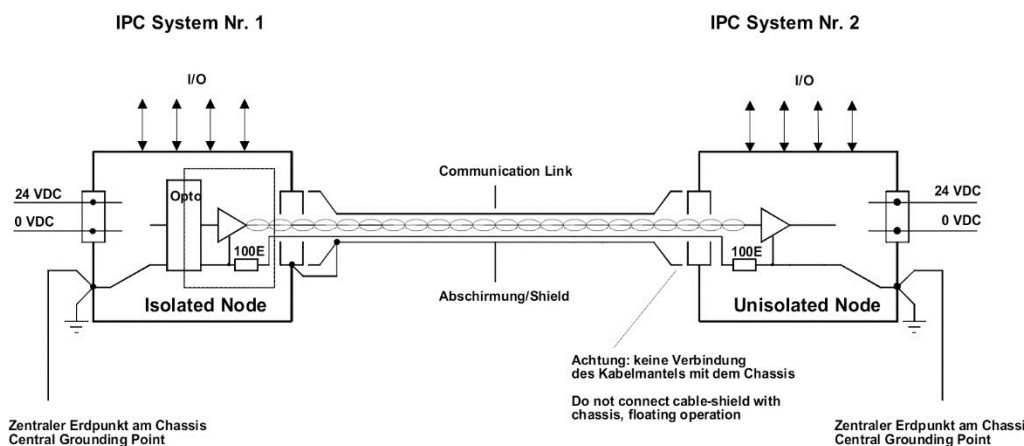

Fig. 17 Isolated communication link

## 5 Service

### 5.1 Replaceable Parts

This M8 system contains the following replaceable parts:

- CFast flash card and SD flash card
- Litium battery
- Main fuse
- Smart or SIM Card

To replace the flash card power off the system and remove the service cover. After having unlocked the clip, the flash card may be removed. When inserting a new flash card be sure that it is fully compliant with the CFast standard. Syslogic highly recommends CFast flash cards specified for industrial use by the card manufacturer. Check temperature range and durability to comply with your requirements.

To replace the battery power off the system and remove the service cover. Pull out the battery carefully.

Replacement battery must be one of the following types:

- Renata CR2450N (3V, 540mAh)
- Renata CR2477N (3V, 950mAh)

Because the self-discharge of all Lithium Batteries increases rapidly at high temperatures the battery life time decreases by a great amount. To prevent battery leakage scheduled service/replacement is recommended. Please contact the battery manufacturer for further details and calculation assistance for battery life time calculation.

The main fuse protects the system against destruction in case of high energy distortions on the power line. For replacement, the system must be opened in a ESD protected environment. Only an entitled instructed person is allowed for this operation. Replacement fuse type is Littlefuse 452004.MRL (4A slow-blow).

Safety warnings and installation guidelines must be followed according to paragraphs 1.5, 1.6, 4 and 6.2.

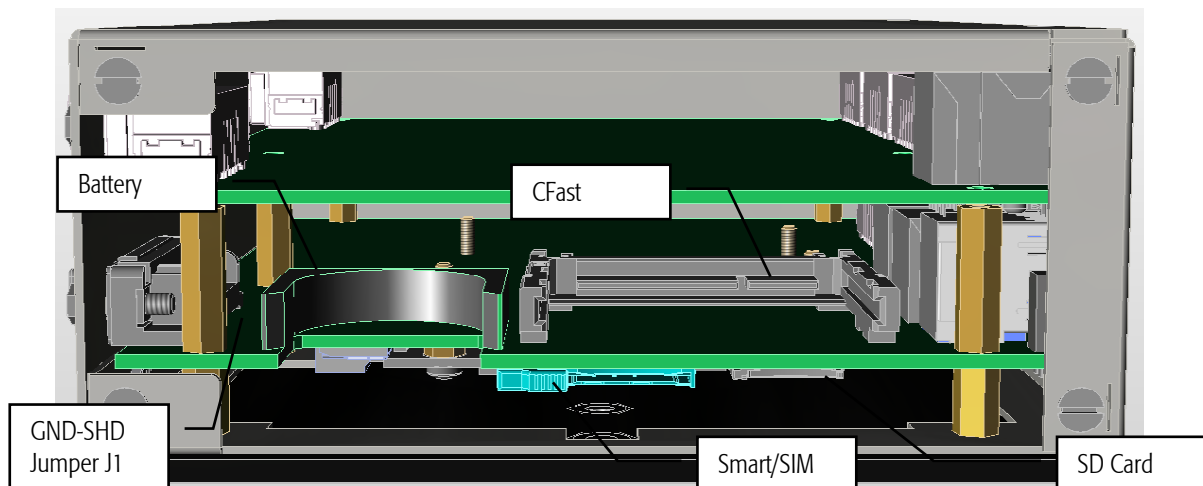

Fig. 18 Service parts replacement

## 6 Technical Data

### 6.1 Electrical Data

#### Important Note

Do not operate the M8 system outside of the recommended operating conditions. Otherwise lifetime and performance will degrade. Operating the board outside of the absolute maximum ratings may damage the hardware.

#### Absolute Maximum Ratings (over free-air temperature range)

Parameter	Symbol	min	nom	max	Unit
power supply voltage	Vcc	-0.5		30	Vdc
isolation logic to chassis (AC, 60s, 500m a.s.l., Ta=25°C)		100	500		Vrms
isolation RJ45 to logic (AC, 60s, 500m a.s.l., Ta=25°C)		1500			Vrms
isolation RJ45 to chassis (AC, 60s, 500m a.s.l., Ta=25°C)		500			Vrms
creepage distances:					
logic to chassis and PCB boarder		1.0			mm
logic to mounting holes		1.0			mm
operating free-air temperature (Ambient)	Ta	-40		70	°C
storage temperature range <sup>1</sup>	Tst	-40		85	°C

Tab. 36 General Absolute Maximum Ratings

<sup>1</sup>Due to the large effect of self-discharge at high temperature of the Lithium Battery it is recommended to store the device at around +25°C.

#### Recommended Operating Conditions

Parameter	Symbol	min	nom	max	Unit
power supply voltage	Vcc	9.0	12/24	30	Vdc
battery backup voltage (Io=100µA)	Vbatt	2.7	3.0	3.3	Vdc
SATA connector (P82) power load (+5V)	Isata			500	mA
PS/2 connector (P4) power load (+5V)	Ips2			50	mA
operating free-air temperature range (CPU load, low GPU load, max Power dissipation < 11W) <sup>(1)</sup>	Ta	-40		65	°C

(1) this parameter is highly dependent on mounting, air flow and GPU load; with the Intel SpeedStep technology the processor automatically reduces the internal cpu clock down to 500MHz when the critical thermal trip points are reached to prevent damage.

Tab. 37 General Recommended Operating Conditions

### Electrical Characteristics (over recommended operating range, unless otherwise noted)

Parameter	Symbol	min	typ	max	Unit
<b>general parameters</b>					
full load power dissipation (worst case, no external loads, IPC/M8H19-A201E)	Pmax			18	W
Normal operation (3 x LAN 1GB/s, 50 CPU load, IPC/M8H19-A201E)	Pnom		9		W
power supply current (Vcc=24V, no external loads, IPC/M8H19-A201E)	Icc		0.4		A
power supply current (Vcc=12V, no external loads, IPC/M8H19-A201E)	Icc		0.5	2.1	A
Power consumption in Sleep mode (S3) and shut down (Vcc=24V)	Psleep		2.1	2.5	W
Power consumption off mode (using Power Management controller)	Ioff		0.45	0.5	W
<b>power fail / remote on/off</b>					
inactive state	PFhigh	2.6		Vcc	V
active state	PFlow	-0.5		2.3	V
<b>RTC backup battery</b>					
Vbatt loading (Vcc=off)	Ibat(off)		4	5	uA
Vbatt loading (Vcc=on)	Ibat(on)		2	4	uA
LOWBAT* trip point		2.35	2.5	2.65	V
VRT trip point (RTC Valid RAM and Time Flag)			1.3		V
Backup time with new CR2450N battery (Ta=25°C)	t(rtcbup)	6	7		years
Backup time with new CR2450N battery (Ta=50°C)	t(rtcbup)	3	3.5		years
Backup time with new CR2477N battery (Ta=25°C)	t(rtcbup)	8	9		years
Backup time with new CR2477N battery (Ta=50°C)	t(rtcbup)	3.5	4		years
<b>USB Supply current</b>					
USB 2.0 Port	Iusb2			500	mA
USB 3.0 Port	Iusb3			1000	mA

Tab. 38 General Electrical Characteristics

### Switching Characteristics (over recommended operating range, unless otherwise noted)

Parameter	Symbol	min	nom	max	
<b>processor characteristics</b>					
processor clock (IPC/M8H19-xxx)	fcpu		1.91		GHz
<b>communication interface characteristics</b>					
UART base clock	fuart		1.8459		MHz
COM1/2/3/4 baud rate				115.2	kbaud
<b>timer/clock characteristics</b>					
Watchdog timeout (short period)	Tw	70	100	140	ms
Watchdog timeout (long period)	Tw	0.7	1	1.3	s
Timer base clock	ftimer		1.19318		MHz
Timer base clock accuracy				+/-100	ppm
Timer base clock aging				+/-5	ppm/year
Real Time Clock base clock	frtc		32.768		kHz
Real Time Clock accuracy (25°C)				+/-20	ppm
Real Time Clock temperature coefficient				-0.04	ppm/(°C) <sup>2</sup>
Real Time Clock aging				+/-3	ppm/year
LCD inverter brightness PWM base clock	fpwm		16		kHz

Tab. 39 General Switching Characteristics

## 6.2. EMI/EMC Data

The M8 system fulfills the following standards:

Emission: EN55032 / CISPR 32 Class A  
EN55022 / CISPR 22 Class A

Immunity: EN55024 / CISPR 24 Class A

### 6.2.1. Restrictions

#### Important Note

This is a Class A product and not intended to be used in domestic environments. The product may cause electromagnetic interference. Appropriate measures must be taken.

#### Important Note

Use power insulated supply if the device is connected to cables going outside.

### 6.2.2. Mechanical Data

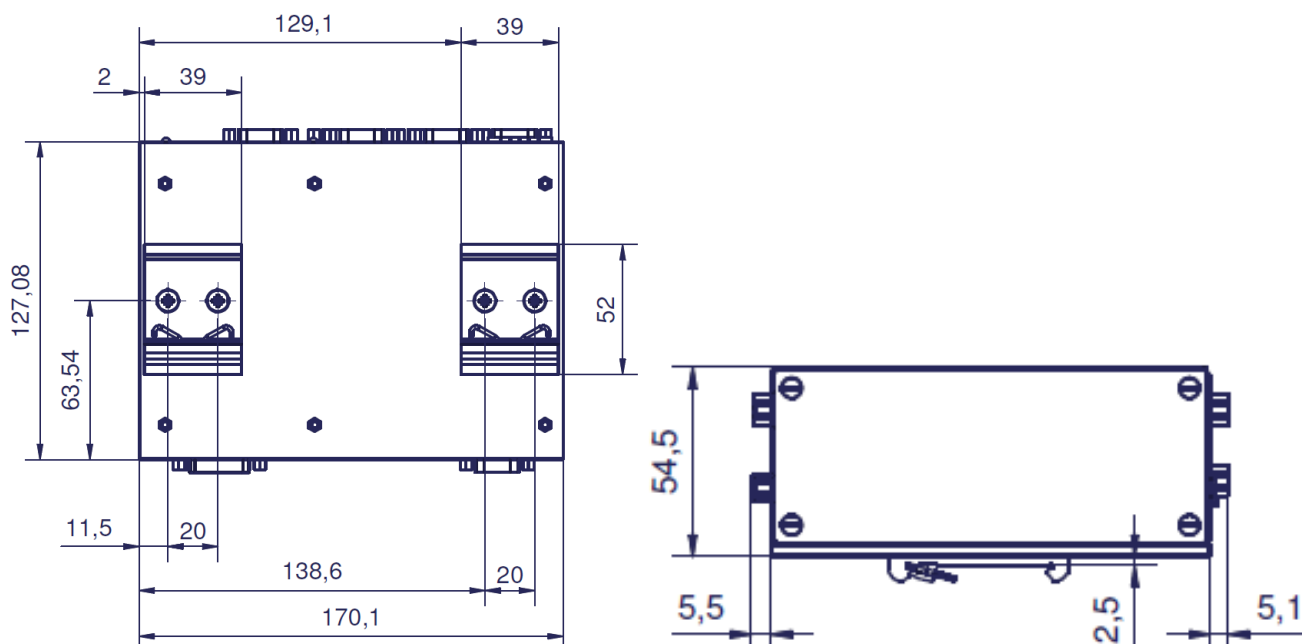

Fig. 19 Drawings (bottom view, side view)

## 7 Firmware

### 7.1 Software Structure

The M8 systems are based on the following software structure:

BIOS (Basic Input / Output System)

Initialization of standard peripheral devices

Boot procedure for the Operating System

**Note:** Refer to the BIOS documentation for detailed information

OS (Operating System)

Initialization of additional peripheral devices

Start procedure for the Application Programs

**Note :** Refer to the OS documentation for detailed information

Application Programs

Initialization of COMPACT system, communications and external devices

Start procedure for the Control Tasks

**Note :** Refer to the Application Programs documentation for detailed information

### 7.2 Firmware Functions

The M8 products do not contain any firmware. Some standard PC/AT peripheral devices (e.g. Serial and Parallel Ports, IDE interface) are directly supported by most BIOS and Operating Systems.

### 7.3 Application Programming Interface (API)

The M8 products do not contain any special API. Refer to the BIOS and Operating System documentation for API specifications.

## 8 Product Revision History

### 8.1. Hardware

This paragraph lists the different hardware revisions of the M8 systems delivered beginning with the first production lot. Note that prototyping boards are not included and must be returned to factory for upgrade or replacement. All information listed in this document relies on definitive state hardware. Therefore this information may be incompatible with the prototyping board hardware.

#### Important Note

This document always covers the newest product revision listed in Tab. 40. Please contact the manufacturer's technical support for upgrade options.

Board Identification (see product label)	Product Revision	Revision ID Register	Remarks
IPC/M8xxx-AxxxE #0	#1	01H	Prototypes
IPC/M8xxx-AxxxE #1	#1	03H	Original Release

Tab. 40 Hardware Revision State

### 8.2. Firmware

This paragraph lists the different firmware versions of the M8 systems delivered beginning with the first production lot. Note that prototyping boards are not included and must be returned to factory for upgrade or replacement. All information listed in this document relies on definitive state hardware. Therefore this information may be incompatible with the prototyping board hardware.

Board Identification (see product label)	BIOS Version	Build Date	Remarks
IPC/ M8Gxx-AxxxE #1	S8D1R001	06.02.2015	Original Release
IPC/ M8Hxx-AxxxE #1	S8D2R001	06.02.2015	Original Release
IPC/ M8Gxx-AxxxE #1	S8D1R011	06.02.2015	Major BIOS updated, different Bugfixes
IPC/ M8Hxx-AxxxE #1	S8D2R011	06.02.2015	Major BIOS updated, different Bugfixes
IPC/ M8Gxx-AxxxE #1	D1R011B	27.06.2016	3.1, default CMOS settings for USB adjusted
IPC/ M8Hxx-AxxxE #1	D2R011B	27.06.2016	3.1, Default CMOS settings for USB adjusted

Tab. 41 Firmware Revision State



## 8.1. Erratas

This paragraph lists some important erratas of the current M8 boards to enable workarounds in user software. Additional erratas might be present but a workaround already implemented in the BIOS. It is important therefore that neither the application software nor the operating systems reprograms the processor chipset's configuration registers.

Note that prototype board erratas (boards with revision #0) are not listed here. Contact Syslogic technical support for prototype board information.

Additional erratas of the processor chipset can be found at:

<https://www.intel.com/content/dam/www/public/us/en/documents/specification-updates/atom-e3800-family-spec-update.pdf>

<b>Watchdog-NMI bug (not working)</b>	
<b>Problem</b>	When Watchdog is configured to activate an NMI, the NMI service routine is not called.
<b>Implication</b>	Watchdog-NMI not usable.
<b>Workaround</b>	none.
<b>Correction</b>	This bug might be a BIOS problem and will be corrected in a future BIOS release.
<b>SDCard Interface bug (not working with some SDCard types)</b>	
<b>Problem</b>	The Intel processor chipset contains several issues in SD and SDIO Hostcontroller which can disturb normal operation of the SDCard interface.
<b>Implication</b>	Some SDCard types will not work reliable.
<b>Workaround</b>	Some of the issues have already been solved by a BIOS workaround, some are dependent on OS drivers and some are not fixable. Check with Syslogic for a list of working SDCard types.
<b>Correction</b>	Some of the issues might be solved by new BIOS and/or OS driver releases, but some are not fixable.

### Important Note

This document always covers the latest product revision listed in Tab 40, 41.

Please contact the manufacturers technical support for upgrade options.

## 9 Manufacturer Information

### 9.1 Contact

Our distributors and system integrators will gladly give you any information about our products and their use. If you want to contact the manufacturer directly, please send an email message containing a short description of your application and your request to the following address or use one of the information or technical support request forms on our internet homepage:

Syslogic Datentechnik AG  
Taefernstrasse 28  
CH-5405 Baden-Daettwil/Switzerland

e-mail: [support@syslogic.com](mailto:support@syslogic.com)  
Web: [www.syslogic.com](http://www.syslogic.com)  
T: +41 56 200 90 50  
F: +41 56 200 90 40

#### 9.1.1 RMA Service

Syslogic offers a Return Material Authorization process to simplify handling of devices that needs to be returned to the manufacturer. Please follow the instructions on our web page: <https://www.syslogic.com/deu/rma.shtml> to get best service.